

RESEARCH REPORT

A VDSL Tutorial

Frank Sjöberg

Research report

Institutionen för Systemteknik
Avdelningen för Signalbehandling

A VDSL Tutorial

Frank Sjöberg

April 2000

Abstract

This report is an introduction to very high-speed digital subscriber lines (VDSL). It gives an overview of the telephone access network and describes in more detail the characteristics of twisted-pair wire-line channel. We describe the different types of noise sources that exist, especially impulse noise, radio frequency interference (RFI), and crosstalk. We also describe some methods to deal with the different types of noise. The problem with radio frequency interference is two-fold and we address both the RFI-ingress and the RFI-egress problem. The different duplex methods and modulation methods proposed for VDSL are presented in this report, with the focus on discrete multitone modulation and the Zipper duplex method. The problem with very unequal levels of far-end crosstalk for different wire lengths is also addressed and we present some different power back-off methods to deal with that problem. Compatibility issues between VDSL and other types of systems are addressed in the last section. The report also contains an extensive bibliography.

Contents

1	Background	7
2	The Access Network Environment	9
3	The Twisted-pair Channel	11
3.1	Bridged Taps	14
4	Noise Sources	15
4.1	Impulse noise	15
4.2	Radio Frequency Interference	16
4.3	Crosstalk	18
5	Line-codes	23
5.1	Carrierless Amplitude/Phase Modulation	23
5.2	Discrete Multitone Modulation	24
5.3	Filter bank based modulation	26
6	Duplexing	29
6.1	Time Division Duplexing	29
6.2	Frequency Division Duplexing	30
6.3	Zipper	30
7	Dealing with Radio Frequency Interference	35
7.1	RFI Egress	35
7.2	RFI Ingress	36
8	Power Back-Off	39
9	Spectral Compatibility	41
9.1	POTS and ISDN	41
9.2	HDSL	42
9.3	ADSL	42
9.4	HPNA	43
9.5	Frequency Plans	43
A	Transmission Line Characteristics	45
A.1	Bridged Taps	47
B	RLCG-parameters	49
C	Alien crosstalk	51

List of Figures

2.1	Schematic picture over a telephone access network.	10
2.2	A bridged tap.	10
3.1	An infinitesimally small part of a transmission line represented by an RLCG-network.	11
3.2	A transmission line modelled as a two-port network with ABCD-parameter description, connected to a source V_S and a load Z_L	12
3.3	Signal attenuation for a 500m long wire and a 1000m long wire. Two different wires are plotted: the TP2-wire ($\emptyset 0.5\text{mm}$) and the TP1-wire ($\emptyset 0.4\text{mm}$).	13
3.4	A simple transformer-coupled hybrid.	13
3.5	Signal attenuation in a TP2-wire (500 meters long) with a bridged tap that is either 10m, 25m or 100m long.	14
4.1	Principle for RFI-ingress.	17
4.2	The principle for occurrence of near-end crosstalk (NEXT) and far-end crosstalk (FEXT).	19
4.3	Power spectral density for NEXT, FEXT, and received VDSL signal on a 500 meter TP1-wire, when the transmit-PSD is flat -60 dBm/Hz.	20
4.4	Transmit PSDs for ADSL, HDSL and ISDN.	21
5.1	QAM and CAP modulation.	24
5.2	Block diagram of a DMT system.	24
5.3	Equivalent DMT channel model.	25
6.1	The Zipper principle.	31
6.2	Illustration of TDD, FDD, and Zipper on a time-frequency grid. The darker color represents upstream direction.	32
6.3	Pulse-shaping in the transmitter.	32
6.4	Windowing in the receiver.	33
7.1	Examples on different RFI-cancellers.	36
7.2	RFI in the frequency domain after the FFT, with and without windowing in the time-domain. The received VDSL signal and VDSL self-FEXT are also shown.	37
8.1	Distributed cable topology.	39
8.2	Example of simplex bit rates in up- and down-stream when full transmit power is used, for the scenario in Figure 20.	40
9.1	VDSL configuration with POTS-splitter separating the VDSL traffic from the POTS traffic.	41
9.2	Scenario where VDSL is delivered from the cabinet and ADSL/HDSL from the central office.	43

A.1	A bridged tap.	47
C.1	ETSI background noise model A and D, for a 1000 meter DWUG cable.	52

Chapter 1

Background

The purpose of this report is to give a basic understanding of digital subscriber lines (DSL), in particular VDSL (very high-speed digital subscriber lines). This report can serve as introductory reading for anybody interested in VDSL, but it also gives background to and summarizes the research that has been made over the last five years at the Division of Signal Processing at Luleå University of Technology in the area of high-speed communication on the telephone access network.

Ever since Alexander Graham Bell invented the telephone back in 1875, the telephone network has continuously grown worldwide and today it consists of around 700 million lines [1]. This existing infrastructure represents a huge capital investment, and the telephone companies around the world are aware of this valuable asset. This has motivated the search for technical solutions that allow the existing telephone network to be used for broadband communication. Over the years a number of different digital subscriber line techniques have evolved that gradually have offered higher data rates. The difference between a digital subscriber line and a traditional modem connection is that a digital subscriber line has modems specially designed for high-speed digital communication at both ends of the wire-line. By replacing the line interface card engineered for speech in the central office (CO), a much larger bandwidth is available for the DSL modem, *e.g.* VDSL can use more than 10 MHz to achieve bit rates up to 52 Mbits/s. Eventually we would all like to have fiber-to-the-home connections to satisfy the ever increasing bit rate demands. But before cost-effective fiber-to-the-home solutions are available, the ordinary telephone network can provide high-speed connections by means of digital subscriber lines.

What often is considered as the first DSL system is the basic rate *integrated services digital network* (ISDN), which was introduced in 1976 [2, 1]. The ISDN connection provides a symmetric bit rate of 128 kbits/s, that is 128 kbits/s in both the downstream direction (to the subscriber) and the upstream direction (to the central office). ISDN also includes a control channel of 16 kbits/s, but that is mostly used for signalling. The next standard following ISDN was the *high bit-rate digital subscriber-line* (HDSL) [3, 4, 5, 6, 7], which also provides a symmetrical connection but with much higher data rates. HDSL can offer 1536 kbits/s in the US and 2048 kbits/s in Europe. The European HDSL can operate on 1, 2 or 3 wire-pairs [3]. Symmetrical data rates in these ranges can support video conferencing of good quality and other services that require high data rate in the upstream direction. Most often it is used for multiplexing many telephone connections into one wire-line, for example from a cellular base station. When the bit rate offered in the downstream direction is larger than the bit rate in upstream direction, it is called an *asymmetric digital subscriber-line* (ADSL) [8, 9, 10, 11, 12, 13]. ADSL is suitable for applications like video on demand, games, internet surfing etc., where most of the data goes from the central office to the subscriber. The existing standard for ADSL supports downstream bit rates from 64 to 8000 kbits/s and the upstream bit rates usually range between

32 and 800 kbits/s. This report focuses on the latest technique called VDSL [14, 15, 16, 17]. As opposed to HDSL and ADSL that offer only symmetrical respectively asymmetrical bit rates, VDSL will support symmetrical as well as different levels of asymmetrical data rates. At the present time no consensus has been reached in standardization of VDSL.

This report is organized as follows: Section 2 gives a general description of the access network environment. This is followed by a more detailed description of the transmission characteristics of the twisted pair wire and the most important noise sources in Sections 3 and 4, respectively. The different types of modulation methods proposed for VDSL and their respective pros and cons are discussed in Section 5, and different duplex methods for VDSL are treated in Section 6. Methods to deal with radio frequency interference are presented in Section 7 and the concept of power back-off is treated in Section 8. Finally, in Section 9 we look at compatibility issues between VDSL and other types of systems.

Chapter 2

The Access Network Environment

This section is intended to give a brief overview of the telephone network environment that the DSL systems operate in. Some important factors to consider in the access network are: type and quality of the wires, length distribution of the wires, network topology, and special impairments like bridged taps.

As the deployment of the telephone network has taken place over a very long time the quality and topology of the network differ greatly between different countries and between different regions within a country. Generally the quality of the network is much better in countries that developed their telephone systems later; the average length of the wires is shorter and the transmission characteristics are often found to be better. For example, the average length of the wires is shorter in most European countries than in the US. The median length of the wires in the access network in Sweden is around 1500m, in Italy around 1200 meters and in the US approximately 2200 meters [1]. The length of the wire is a very important factor since a longer wire attenuates the signal more, resulting in lower bit rate capacity. Other important properties of the wires that determine the transmission characteristics are: dimension (gauge), isolation material (paper, PVC, polyethylene) and type of twisting. Some older telephone networks can have untwisted wire-pairs (also called flat twist), but modern access networks generally consist of unshielded twisted-pair copper wires. Twisted-pair wires are less susceptible to crosstalk and other types of interference (*c.f.* Section 4). The transmission characteristics of the twisted-pair wires are studied in more detail in the following section.

Figure 2.1 shows a simplified schematic picture of a telephone network, where all telephone lines start at a central office (CO) or a smaller local exchange (Ex). A large CO can serve over 100,000 customers. The individual wire-pairs are twisted together into so-called quads of four wires, or into larger binder-groups of around 10 wires in each group. Groups of wires are then bundled together into larger cables with 50-100 wire-pairs, and cables can be gathered together to constitute large feeder cables with several thousand wire-pairs. The big feeder cables of subscriber lines emanate from the CO. As the network spreads out, the big cables branch off into smaller and smaller cables. At some junctions in the network there are so-called crossconnection points, where crossconnections between wires in the larger feeder cables and the smaller distribution cables can be made. The crossconnection points often reside in small street cabinets, and are known by many names, such as a serving area interface, a flexibility point, or a crossbox, etc. The gauge of the cables often changes in a crossconnection point, where smaller gauges are used closer to the CO to make the large cables easier to handle, and large gauges are found closer to the customer premises. Most of the network is buried underground, especially the large feeder cables. But aerial wires can also exist and they are more common further out in the network closer to the subscribers. However, buried wires are preferred since aerial wires are more susceptible to ingress noise, and are more likely to create egress problem, see Section 7.

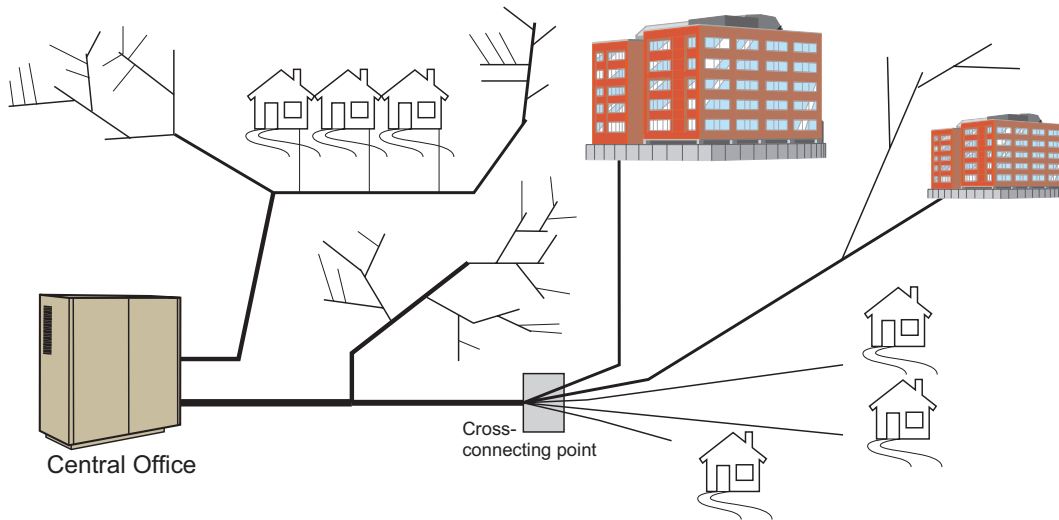

Figure 2.1: Schematic picture over a telephone access network.



Figure 2.2: A bridged tap.

Special types of impairments present in some access networks are so-called bridged taps [18]. A bridged tap is an unterminated line-segment that is spliced onto the telephone line, see Figure 2.2. This was made before, to allow reconfiguration of the network (disconnecting some and reconnecting other subscribers) if service demands would appear at other locations. Bridged taps are usually located closer to the customers than the central office, and they are more common in North America than in Europe. It is estimated that up to 80% of the lines in the US have bridged taps [1], but they can exist in Europe as well. If we consider the indoor wiring at the customer premises as part of the access network (which is the case with a splitter-less DSL system), practically all lines have bridged taps. The effect of bridged taps on a VDSL signal is explained in Section 3.

The traffic into a CO is most often carried by optical fibers today, and in countries with many short telephone lines, VDSL can initially be deployed from the CO and still reach many users. In the US, however, where the lines are longer than in most European countries, a central office based deployment of VDSL would not reach the majority of the customers. Therefore there is also a large interest in *fiber-to-the-cabinet* solutions, where optical fibers are drawn out to the crossconnection points and the VDSL modems are installed in the street cabinets. An important issue to consider here is power consumption. In the central office power supply, space and cooling are not of major concern. But if VDSL is installed in the crossconnection cabinets low power consumption is a critical issue. Low power consumption is of course desirable for a central office based scenario also, but not critical. In a scenario where the normal phone service is replaced by a VDSL in-band telephone service, power consumption is important since a lifeline must be provided in the case of power-failure.

Chapter 3

The Twisted-pair Channel

In this section we will study the characteristics of the twisted-pair telephone line. The channel transfer function is of special interest, but phenomena like bridged taps, impedance matching, and signal reflection are also considered.

Within VDSL's frequency range, the twisted-pair wire can be seen as a transmission line. Thus many of the characteristics of the twisted-pair wire can be derived from traditional transmission line theory [19, 20]. The purpose of this section is to give a short description of the more interesting properties of twisted-pair wire. The interested reader is referred to some of the many good textbooks that cover this area thoroughly [19, 20, 21].

The traditional approach to study the transmission line is to model an infinitesimally small part of the wires, as in Figure 3.1. The resistance R , inductance L , capacitance C , and conductance G (all per length unit), known as the RLCG-parameters, characterize the behavior of the transmission line. The RLCG-parameters are usually frequency dependent but are assumed to be independent of length (or position). The *characteristic impedance* of the transmission line is defined as

$$Z_0 = \sqrt{\frac{R + j2\pi fL}{G + j2\pi fC}}, \quad (3.1)$$

and is an important parameter to consider when using the wire-line. We are interested in what happens when the line is connected to a source V_S with impedance Z_s and terminated with a load impedance Z_L . This is illustrated in Figure 3.2 where the transmission line is modelled as a two-port linear circuit with ABCD-parameter description [22]. The derivation of the transfer function is performed in Appendix A. If the line is terminated with an impedance matching

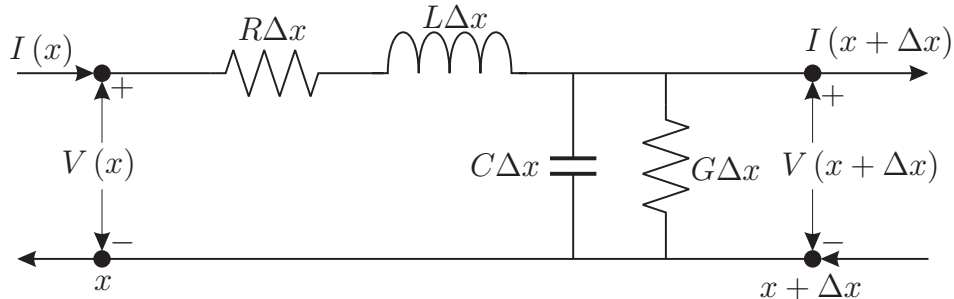

Figure 3.1: An infinitesimally small part of a transmission line represented by an RLCG-network.

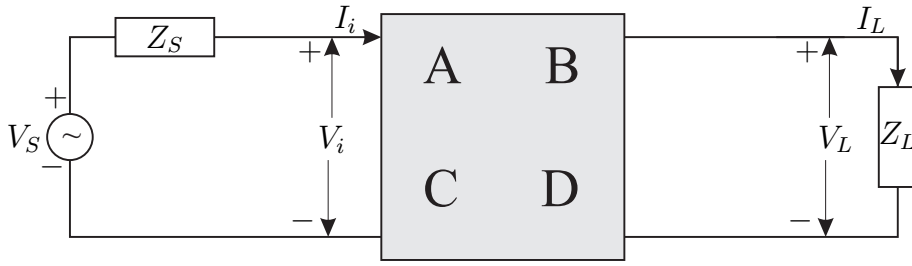

Figure 3.2: A transmission line modelled as a two-port network with ABCD-parameter description, connected to a source V_S and a load Z_L .

the characteristic impedance, that is $Z_L = Z_0$, the *transfer function* becomes

$$H(f, d) = \frac{V_L}{V_S} = \frac{1}{2} e^{-d\gamma(f)}, \quad (3.2)$$

where d is the length of the wire, and $\gamma(f)$ is *propagation constant* that is defined as

$$\gamma(f) = \sqrt{(R + j2\pi fL)(G + j2\pi fC)}. \quad (3.3)$$

Closely related to the transfer function is the *insertion loss* [1], which is defined as the ratio between the voltage over the load, Z_L , with the wire-line *inserted* between the source and load, and the voltage over the load when it is connected directly to the source without the wire-line in between:

$$T_{IL}(f, d) = \frac{Z_S + Z_L}{Z_L} H(f, d). \quad (3.4)$$

When working with DSL systems it is often more relevant to use the insertion loss than the transfer function. This is because the specified limitations for the power spectral density (PSD) of the transmitted signal [14, 15], applies to the *insertion point* where the signal is inserted into the wire, not at the source itself. In most practical cases the source impedance and load impedance is fairly well matched to the characteristic impedance, and then the transfer function is simply 6 dB lower than the insertion loss. In many cases it is actually the insertion loss that is referred to as the transfer function.

From (3.3) and (3.2) one sees that the transfer function depends on the length of the wire and the RLCG-parameters. Quite accurate models of the frequency dependent RLCG-parameters have been derived from measurements on different cables. In Appendix B, models for the RLCG-parameters are given for some typical wires. Figure 3.3 shows the insertion loss for two of those, the TP1 and the TP2 wires [14]. For VDSL, which uses a quite large frequency range (greater than 1 MHz), the transfer function can be approximated as

$$H(f, d) = \frac{1}{2} e^{-dk\sqrt{f}}, \quad (3.5)$$

where d is the length of the wire and k is a wire-constant. This model is often used when VDSL and HDSL systems are analyzed [23, 24].

If the source- and load-impedance are not matched to the characteristic impedance of the line part of the outgoing signal (wave) will be reflected back. The reflection coefficient ρ_r represents how much of the signal that is reflected back and is defined as:

$$\rho_r = \frac{Z_L - Z_0}{Z_L + Z_0}. \quad (3.6)$$

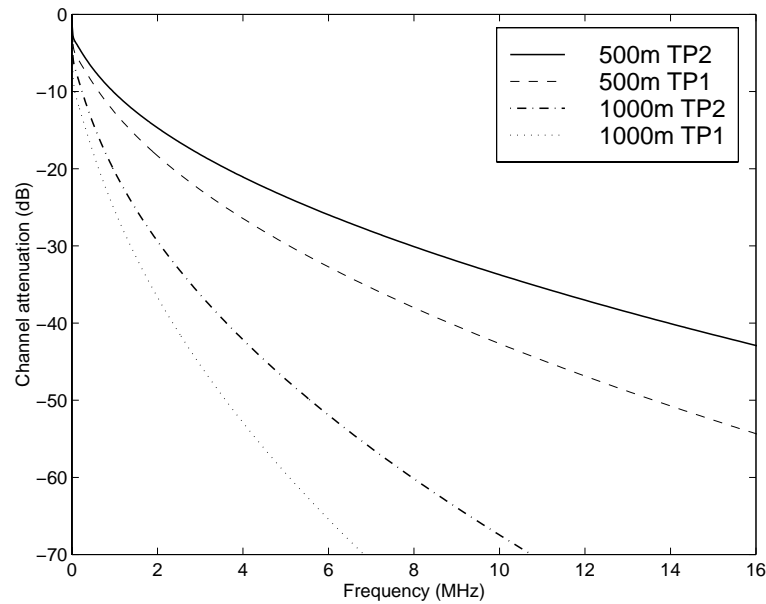

Figure 3.3: Signal attenuation for a 500m long wire and a 1000m long wire. Two different wires are plotted: the TP2-wire ($\emptyset 0.5\text{mm}$) and the TP1-wire ($\emptyset 0.4\text{mm}$).

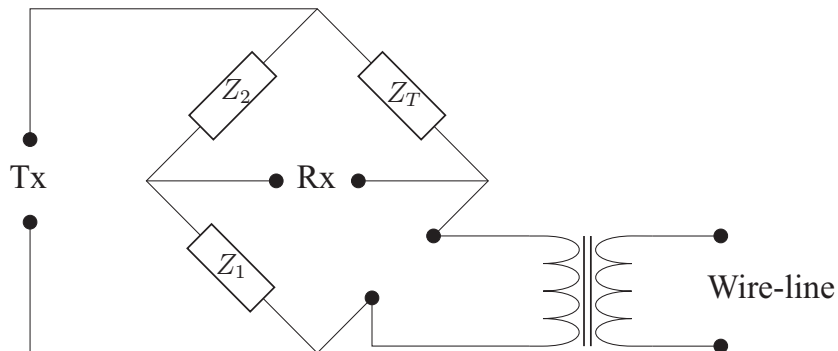

Figure 3.4: A simple transformer-coupled hybrid.

It is important to keep the reflection coefficient as small as possible because strong reflections can disturb the communication and cause problems with saturated analog-to-digital converters (ADC). If the line is terminated with an impedance matching the characteristic impedance Z_0 , the reflection coefficient becomes zero and there is no reflected signal. A transformer coupled balun or hybrid is often used to terminate the wire and to connect the communication equipment to the wire-line. Figure 3.4 shows a schematic drawing of a simple hybrid. A hybrid is used when the same wire-pair is used for transmission and reception at the same time. If Z_T is made equal to Z_0 , then Z_1 should be chosen equal to Z_2 so that the transmitted signal is not coupled into the receiver.

Another interesting property of the twisted-pair wires is the average propagation speed of a VDSL signal. This can be derived by calculating the group-delay from the transfer function. For most types of wires the wave propagation speed is close to $2/3$ of the speed of light in vacuum,

$$c_{cu} \approx 2 \cdot 10^8 \text{ m/s.} \quad (3.7)$$

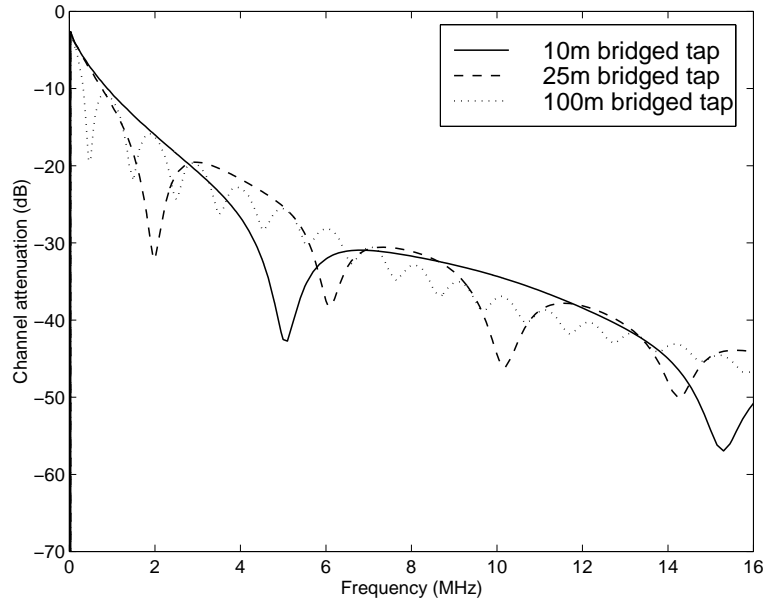

Figure 3.5: Signal attenuation in a TP2-wire (500 meters long) with a bridged tap that is either 10m, 25m or 100m long.

3.1 Bridged Taps

To derive a model for a wire-line with a bridged tap (see Figure 2.2) one can view the whole line as a concatenation of three parts; the line before the bridged tap, the bridged tap itself and the line after the bridged tap. The analysis of a bridged tap is found in Appendix A.1. If all the sections of the wire-line with the bridged tap consist of the same type of wire, and if the source and load impedance are matched to the characteristic impedance, then the insertion loss is given by:

$$T_{IL}(f) = \frac{e^{-\gamma(d_1+d_2)}}{\left(1 + \frac{1}{2} \tanh \gamma d_{BT}\right)}, \quad (3.8)$$

where d_{BT} is the length of the spliced bridged tap segment, and d_1 and d_2 are the lengths of the wire segments from the central office to the bridged tap and from the bridged tap to the customer, respectively.

One way of interpreting the effect of the bridged tap is to study how a sinusoidal signal is affected. Since the bridged tap is not terminated, part of the signal will be reflected back into the line again. When the length of the bridged tap is one quarter of the wavelength of the signal, the total round-trip delay of the reflected signal will be one half of a wavelength and the reflected wave will add destructively. Figure 3.5 shows how a wire-line with a bridged tap attenuates a VDSL signal on a 500 meter long TP2-wire. For shorter bridged taps, the notches in the spectrum are deeper but farther apart. The effect of bridged taps on VDSL has been studied in [18] and in many standardization contributions [25, 26].

Chapter 4

Noise Sources

The telephone network is not as clean and noise free an environment for digital communication as one might think. The VDSL signal will be disturbed by noise from many different sources due to the fact that an *unshielded* twisted-pair wire is used as channel [27]. The long wires act as large antennas susceptible to many kinds of disturbances. The most important noise sources in the subscriber-line environment are *crosstalk* from other wire pairs in the same cable, *radio frequency interference* (RFI) from nearby radio transmitters, and *impulse noise* from relays, switches, electrical machines, etc. Additive white Gaussian noise (AWGN) is often used to model thermal noise and constitutes a background noise floor. This AWGN noise floor is assumed to have a spectral density of -140 dBm/Hz in the standards specifications [14, 15]. In the following subsections impulse noise, RFI and crosstalk are described in more detail.

4.1 Impulse noise

Impulse noise is difficult to characterize completely but large efforts have been made to measure and model this kind of disturbance [28, 29, 5, 30, 31]. The problem with describing impulse noise lies in the non-stationary nature of the sources and the large variety of them. It is not possible to just define a probability density function and a power spectral density that models the statistics of any type of impulse noise.

One important classification of the different types of noise sources can be made: impulse noise originating from regular telephone activity, and impulses from external sources like home appliances, engines, fluorescent lightning, relays. Certain activities of the ordinary telephone service like lifting or putting down the hook, and ring-signals that switch on and off, are generally associated with rapid voltage changes. This is especially true for older line cards with analog relays and they can create very strong impulses. Impulse noise from the *plain old telephone service* (POTS) is not only a problem on the line it originates from. It can also disturb neighboring wire-pairs through FEXT and NEXT couplings.

Large surveys of impulse noise have been performed by Bellcore and NYNEX [31], British Telecommunications (BT) [28, 32, 33, 34, 35] and Deutsche Telekom AG (DTAG) [29, 36]. In the older surveys the measurement bandwidth was much smaller than the VDSL bandwidth, but they still provide good insight into the nature of the impulse noise. Even if not stated explicitly in the reports, it can be concluded from the derived statistics that the majority of the impulses recorded in these surveys originate from POTS-activity.

Depending on many different parameters such as measurement-bandwidth, threshold settings, definition of “an impulse”, recording length, test-line setup etc., the recorded statistics can vary from study to study. The results from most surveys though are somewhat in agreement. The average length of an impulse is found to be around 2-20 μ s, and usually less than 1% of the impulses are longer than 200 μ s. The interarrival times between the impulses can

vary from a few μs up to hours. Poisson distributions as well as Pareto distributions have been suggested for modeling the interarrival time [33]. Assuming that events generating impulses are independent the Poisson distribution makes sense. But the impulses seem to come in bursts, and the bursts also seem to occur in bursts of bursts (in a larger time scale) and so on. This self-similarity indicates that a Pareto distribution should fit well [37]. In [33] a Markov renewal process model is suggested, where ranges of interarrival times represent the Markov states and either a Pareto or a Poisson distribution is chosen in each state to model the interarrival time. In the study by BT it was found that the interarrival time between impulse-bursts corresponds well to the cadence of the ring-signal [28].

In a mathematical sense impulse noise is not a stationary process, thus there exists no well-defined power spectral density (PSD). However, it is still interesting to study the frequency characteristics of the impulse noise and a pseudo PSD can be defined. The pseudo PSD is calculated over a certain time span, which can be the average length of an impulse for example [36]. For multicarrier systems like *discrete multitone* (DMT) [23, 6, 38] it makes sense to calculate the pseudo PSD over the time spanned by one DMT symbol, since that indicates the effect impulse noise will have on a DMT system. The PSD of impulse noise seems to be fairly flat but with a slight increase for lower frequencies. In [36] levels of around -90 to -100 dBm/Hz were often recorded, and for frequencies below 1 MHz the PSD could be above -80 dBm/Hz. These levels of the pseudo PSD are in accordance with results from a preliminary study made at Telia Research in Luleå [39].

Based on results from the survey at BT [28] a symbolic pulse, called the Cook pulse, was derived

$$p_{\text{cook}}(t) = \text{sign}(t) V_p |t|^{-3/4}, \quad (4.1)$$

where V_p is a constant determining the strength of the pulse. The Cook-pulse is singular at $t = 0$ and it has infinite energy, and hence is not physically realizable. Nevertheless, the spectral characteristics correspond well with the average spectrum of impulse noise recorded in the study by BT. The Fourier transform of the Cook-pulse is

$$P_{\text{cook}}(f) = jAf^{-1/4} \quad (4.2)$$

where A is a constant related to V_p . One symbolic pulse can not represent all different types of impulses, but it is often used to model impulse noise in DSL systems. A sampled version of the Cook-pulse is used to model impulse noise in HDSL, with $V_p = 1.775 \mu V$ as worst case [3].

The normal way to mitigate the effects of impulse noise in a DSL system is to use a system margin of around 6 dB [40] and to use specially designed codes [41]. The system margin represents the amount of extra noise the system can tolerate without exceeding a certain specified symbol error rate. Other promising noise mitigation strategies involve different kinds of detection schemes in connection with erasures in a coding scheme [42, 43]. The detection can be made on the time-domain signal by monitoring clipping in the ADC [42] or in the frequency domain using statistics from some of the tones [43]. These types of detection and erasure schemes show large improvements over coding schemes without erasures.

Normally DMT is considered more resistant to impulse noise of moderate strength than single-carrier systems such as *carrierless amplitude/phase* (CAP) modulation [44, 45]. The energy of the impulse is spread out over all DMT-tone and becomes less harmful. On the other hand, for very strong impulses a whole DMT symbol can be damaged, and it is argued that CAP is more robust in such a case [46].

4.2 Radio Frequency Interference

A type of noise source that has become more of a problem with the development of VDSL is radio frequency interference (RFI). VDSL occupies a much larger frequency range, up to 20

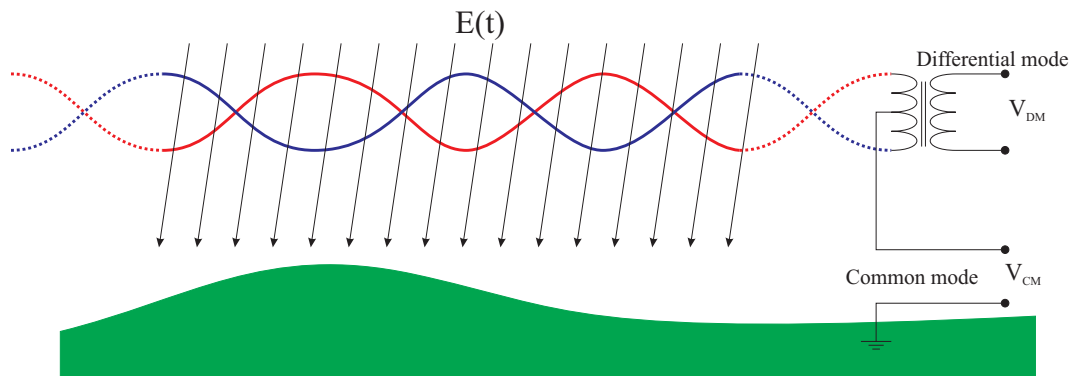

Figure 4.1: Principle for RFI-ingress.

MHz, than precursors like HDSL and ADSL. Since there are many radio systems that operate on frequencies within the VDSL band, there is a potential spectrum compatibility problem between VDSL and radio frequency users. This is because an unshielded twisted wire works like a large *common mode* (CM) antenna that can both receive and transmit radio signals.

Figure 4.1 shows how a twisted-pair wire in a time-varying electromagnetic field receives an induced voltage between either of the wires pairs and ground. This voltage is almost equally strong on both wires and is called the *common mode* signal. However, VDSL signals are transmitted and received as *differential mode* (DM) signals. The twisting causes the voltage induced between the two wires in one *twist* to be cancelled by the almost equally strong voltage with opposite polarity induced in the next twist, see Figure 4.1. Thus the twisting of the wires significantly reduces the differential mode RFI, but the twisting never completely eliminates the differential mode RFI signal. A certain amount of the common mode signal is always converted to differential mode due to non-perfect balance of the wire [47]. The VDSL equipment itself must also be well balanced otherwise it can also cause CM-to-DM conversion. The balance of a twisted-pair wire decreases with increasing frequency and therefore the wire-line is more susceptible to RFI on higher frequencies. It should be noted that while the RFI problem is more pronounced on aerial wires, buried wires could also receive a considerable level of RFI. In a study by Broadcom [48] it is reported that an aerial wire receives about 10 dB more RFI than a buried wire, but quite large variations can exist.

The main source of RFI is believed to be amateur radio (HAM) transmitters. This is because they can be located just a few meters from a telephone line [47] and the transmitting power can be relatively high – up to 400 W in the UK and 1.5 kW in the USA. Even though AM broadcast transmitters use much higher transmit power, they are usually not located so close to the telephone wires. The number of active AM transmitters is also quite small compared to the number of amateur radio users, particular in Europe. Furthermore, AM-broadcast transmitters always transmit the carrier wave, which makes them more stationary and easier to deal with, compared to amateur radio users that can change frequency often and mostly transmit single side-band (SSB) modulated signals.

As a worst case we can consider a scenario where the next-door neighbor is an amateur radio user who uses very large transmit power. A telephone line located 10 meters from a HAM-radio that transmits with 400 Watts can receive a CM-voltage up to 10 Volts [47]. Assuming a balance of around 34 dB the differential mode voltage can be up to 200mV. This corresponds to -5 dBm signal power for a wire with a characteristic impedance of $Z_0 = 130$, and a noise-PSD of -40 dBm/Hz if the bandwidth of the radio signal is 3 kHz. This should be compared to the nominal limit for the transmit PSD of VDSL that is -60 dBm/Hz. Even though the power of

the RFI decreases approximately proportionally to the square of the distance between the wire and the transmitter [28], the RFI can be stronger than the received VDSL signal even if the distance to the HAM-radio transmitter is larger than 100 meters. However, radio amateurs are only allowed to operate at certain frequencies, called the HAM bands. The HAM bands below 20 MHz recognized by ETSI [15] are listed in Table 4.1.

Table 4.1: Amateur radio bands overlapping the VDSL spectrum.

Band start (MHz)	1.81	3.50	7.00	10.10	14.00	18.068
Band stop (MHz)	2.00	3.80	7.10	10.15	14.35	18.168

The VDSL system requirements from ANSI [14] and ETSI [15] specify special test requirements that VDSL should be able to handle. These specifications differ slightly between ANSI and ETSI, but both include 10 AM-broadcast frequencies with 10 kHz bandwidth, most of them below 1.5 MHz. The signal strength of the received RFI varies between -40 dBm and -80 dBm in the ETSI specifications and between -30 dBm and -70 dBm in the ANSI specifications. For RFI from amateur radio the bandwidth is assumed to be at most 5 kHz and the signal strength is specified to 0 dBm by ETSI and -10 dBm by ANSI. This represents a worst case scenario.

In Section 7 different methods for combating RFI are presented. There we will also address the egress problem, with VDSL disturbing radio frequency users.

4.3 Crosstalk

When many unshielded twisted-pair wires are bundled together into thick cables, signals will leak over from one wire to other wires. This signal leakage is known as crosstalk and has been extensively studied since the beginning of the last century [49, 50, 51]. Crosstalk is one of the most important types of noise to consider for VDSL systems.

There are basically two different forms of crosstalk: *near-end crosstalk* (NEXT) and *far-end crosstalk* (FEXT), see Figure 4.2. NEXT occurs mostly at the central office when the weak upstream signal is disturbed by strong downstream signals. FEXT is crosstalk from one transmitted signal to another in the same direction, and appears at both ends of the wire loop. NEXT is the stronger type of crosstalk and can severely limit the performance if not taken care of. NEXT can be avoided by sharing the capacity between the upstream and downstream with some duplex method, *c.f.* Section 6. Near-echo is a special case of NEXT that occurs between a transmitter and a receiver in the same modem, but can be reduced with an echo-canceller [52, 53].

The characteristics of the NEXT and FEXT can be derived from transmission line theory, but that analysis is beyond the scope of this report. The spectral density of NEXT can be modelled fairly accurately as [5]

$$P_N(f) = P_s(f) K_N f^{3/2} (N/49)^{0.6}, \quad (4.3)$$

and the spectral density of FEXT as

$$P_F(f, d) = P_s(f) K_F f^2 d |H(f, d)|^2 (N/49)^{0.6}, \quad (4.4)$$

where $P_s(f)$ is the spectral density of the transmitted signals, d is the length of the wire in meters, N is the number of disturbers, and K_N and K_F are crosstalk constants. Note that NEXT does not depend on the length d of the wire pair. When several disturbers are present

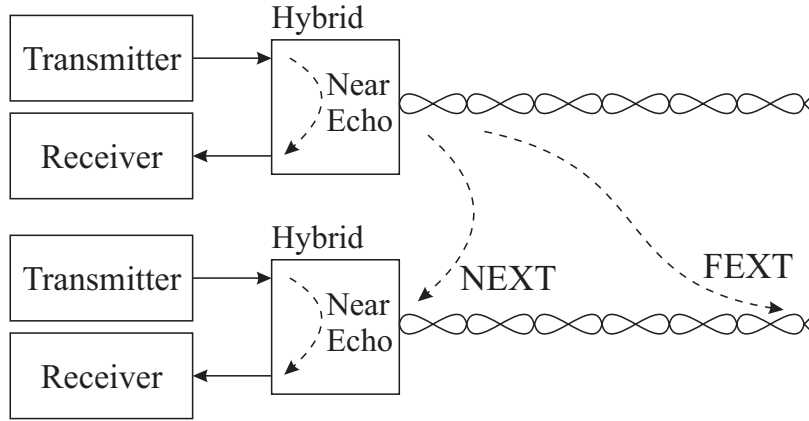

Figure 4.2: The principle for occurrence of near-end crosstalk (NEXT) and far-end crosstalk (FEXT).

the amplitude distribution of crosstalk tends to be Gaussian [5]. The crosstalk constants are given by ETSI in [15] as

$$K_N = 10^{-13} \quad (4.5)$$

$$K_F = 3.27 \cdot 10^{-18}. \quad (4.6)$$

Figure 4.3 displays an example of the power spectral density of a received signal, NEXT, and FEXT on a 500 meters long TP1-wire.

The exponent 0.6 on the number of disturbers N in (4.3) and (4.4) can look somewhat counter intuitive. One might think that the level of crosstalk should be proportional to the number of crosstalkers N . But the models for crosstalk defined in (4.3) and (4.4) do not represent an average value of the crosstalk but rather a 1% worst case. In other words, the probability that the true crosstalk exceeds the level given by (4.3) and (4.4) is less than 1%. The true level of crosstalk depends on the proximity of the disturbers to the disturbed wire. The exponent 0.6 on the number of crosstalkers N reflects the fact that when more crosstalkers are present, some of them have to be located further away from the disturbed wire and thus create less crosstalk. In order not to over estimate the total crosstalk when crosstalk from different systems, e.g. ADSL and HDSL, are added together the following model for adding crosstalk is adopted by FSAN¹ [54]:

$$P_N(f) = K_N f^{3/2} \left(N_1 P_{s_1}(f)^{\frac{1}{0.6}} + N_2 P_{s_2}(f)^{\frac{1}{0.6}} \right)^{0.6} \quad (4.7)$$

$$P_F(f) = K_F f^2 d |H(f, d)|^2 \left(N_1 P_{s_1}(f)^{\frac{1}{0.6}} + N_2 P_{s_2}(f)^{\frac{1}{0.6}} \right)^{0.6}, \quad (4.8)$$

where P_{s_1} and P_{s_2} represent the transmit PSD's for two different kinds of crosstalkers. However, if the true PSD of two independent crosstalkers were known one could simply add the PSD's directly.

Different types of noise, NEXT, FEXT and AWGN are modelled as independent noise, and their respective variance, or PSD, are simply added when the total noise is calculated [54]

$$\sigma_{\text{Total noise}}^2 = \sigma_{\text{AWGN}}^2 + \sigma_{\text{FEXT}}^2 + \sigma_{\text{NEXT}}^2. \quad (4.9)$$

From VDSL's perspective, crosstalk from other VDSL modems is called self-FEXT (and self-NEXT), whereas crosstalk from other types of systems is often referred to as alien crosstalk.

¹Full service access networks (FSAN) is a group of telephone operators.

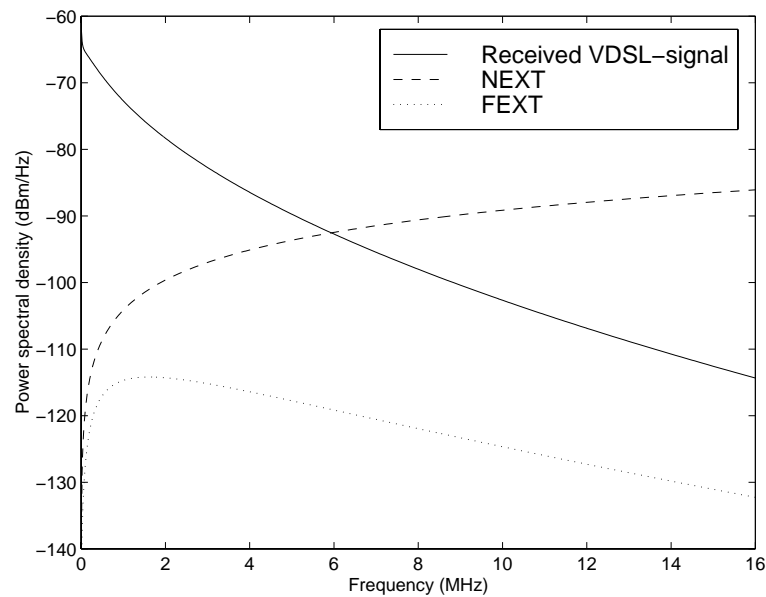

Figure 4.3: Power spectral density for NEXT, FEXT, and received VDSL signal on a 500 meter TP1-wire, when the transmit-PSD is flat -60 dBm/Hz.

For VDSL, crosstalk from ADSL, HDSL and ISDN is considered to be alien crosstalk and together with AWGN it can be considered to be part of the background noise. Models for alien crosstalk, as defined by ANSI and ETSI, are given in Appendix C. Figure 4.4 shows the transmit PSD of the different types of alien crosstalkers. For different future scenarios, different models for background noise, consisting of AWGN plus alien crosstalk, have been defined based on different mixes of other types of services [55]. Two of these background noise models are found in Appendix C.

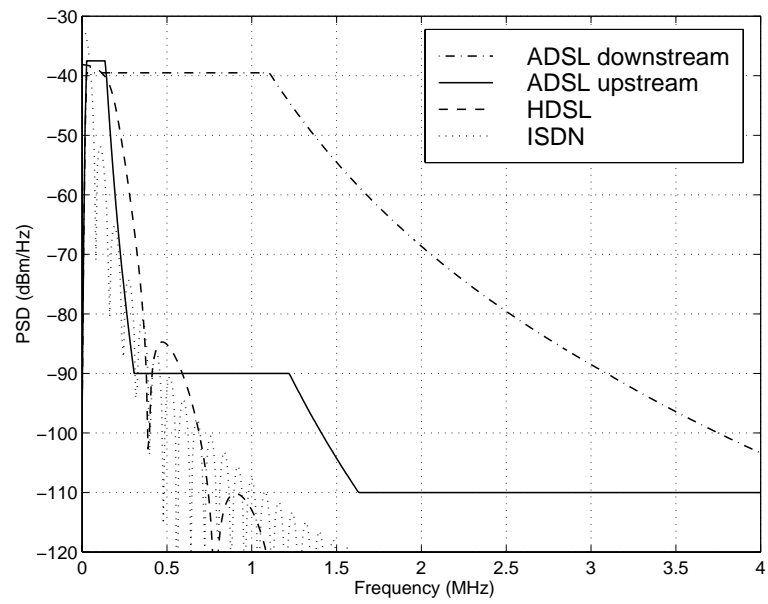

Figure 4.4: Transmit PSDs for ADSL, HDSL and ISDN.

Chapter 5

Line-codes

For wire-line communication the choice of digital modulation scheme is popularly referred to as line-code. The term line-code reflects the precoding of the data that often takes place to spectrally shape the transmitted signal. The telephone channels can normally not carry a DC-component since they are often transformer-coupled in order to electrically isolate the systems at the different ends of the wire-pair. This is the reason why it is desirable to generate a modulated signal with no spectral component at or near DC. An example of this type of coding is alternate mark inversion (AMI) [52], which is used in some ISDN systems [56].

In this section the two major competing modulation methods for VDSL, CAP and DMT, are described. Two other interesting modulation methods based on filter banks are briefly described also.

5.1 Carrierless Amplitude/Phase Modulation

One modulation method that is proposed to be used for VDSL is carrierless amplitude/phase (CAP) modulation [57, 58, 59]. CAP was introduced by Werner and is essentially a different implementation of traditional quadrature amplitude modulation (QAM) [60], and gives practically the same performance. Figure 5.1 shows the principle for a CAP system and a QAM system. Describing it mathematically the signal in a QAM system can be expressed as

$$x(t) = \sqrt{2} \sum_{k=0}^{\infty} x_I[k] g(t - kT) \cos(2\pi f_c t) + x_Q[k] g(t - kT) \sin(2\pi f_c t) \quad (5.1)$$

and the transmitted signal from a CAP system is given by

$$x(t) = \sqrt{2} \sum_{k=0}^{\infty} x_I[k] g(t - kT) \cos(2\pi f_c (t - kT)) + x_Q[k] g(t - kT) \sin(2\pi f_c (t - kT)), \quad (5.2)$$

where $x_I[k]$ and $x_Q[k]$ are the transmitted in-phase and quadrature-phase data at time-instant k . The only difference is the phase-shift, $2\pi f_c T$, of the carrier between subsequent transmissions. The advantage of CAP over QAM is a simpler implementation. The modulation of the baseband signal with the quadrature carriers is not necessary with CAP since it is part of the transmit-pulse. This is possible when the carrier frequency is in the same order of magnitude as the symbol rate, but it is not feasible for radio systems where the carrier frequency is much larger.

The key advantages with CAP are ease of implementation, and that many companies and engineers around the world are familiar with the QAM/CAP technique. This is what makes it an attractive choice for VDSL for some [61].

A critical part of a CAP system is the equalizer that is needed to compensate for the dispersion in the wire-line channel. A minimum mean-square error decision feedback equalizer

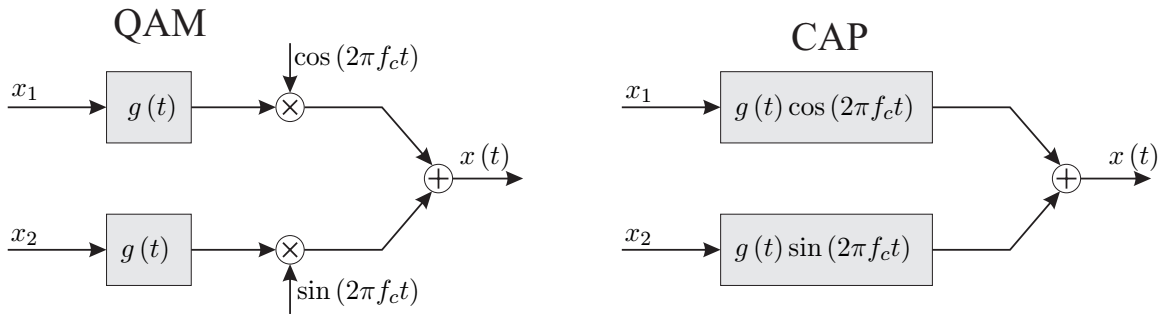

Figure 5.1: QAM and CAP modulation.

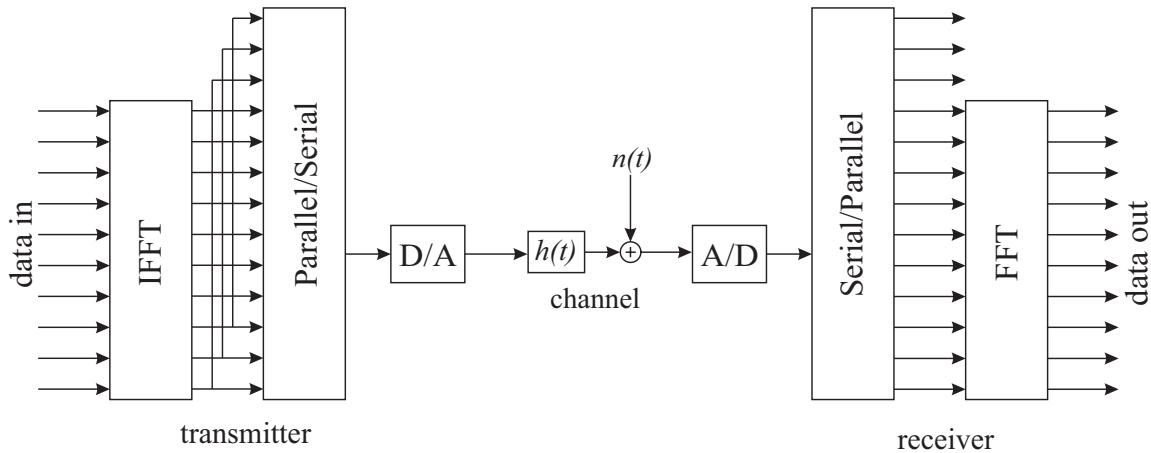

Figure 5.2: Block diagram of a DMT system.

(MMSE-DFE) [62, 52] is preferably used, and since the wire-line channel is almost stationary it is possible to use precoding in the transmitter, such as Tomlinson-Harashima precoding [63, 64, 65], to avoid error propagation. The equalizer can also be designed to handle radio frequency interference, which is addressed in Section 7.

While the modulation and demodulation of CAP signals exhibit low complexity the equalization can become quite computationally demanding for VDSL [45]. The channel impulse response of the twisted-pair channel can be rather long considering the high symbol rates that will be used in VDSL. This means that the equalizer filters generally have to be quite long too.

5.2 Discrete Multitone Modulation

Discrete multi-tone (DMT) modulation [23, 6, 38] is a multicarrier scheme [66, 67, 68] that is similar to orthogonal frequency division multiplexing (OFDM) [69, 70, 71] used in radio systems like the European broadcast systems for audio and video (DAB and DVB [72, 73]). OFDM and DMT are essentially the same technique, but one difference is that with DMT the constellation size on each carrier is adjusted depending on the available signal-to-noise ratio (SNR). This is called bit-loading [40]. DMT was chosen as the modulation scheme for the ADSL standard [8, 11] and is a candidate for VDSL also.

A schematic picture of a DMT system is shown in Figure 5.2. As in OFDM systems the modulation is performed by an inverse fast Fourier transform (IFFT). To avoid intersymbol interference (ISI) and intercarrier interference (ICI) a cyclic prefix (CP) [74] is appended at

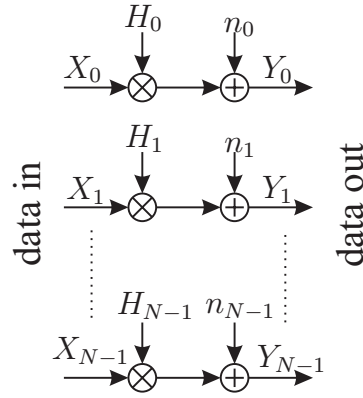

Figure 5.3: Equivalent DMT channel model.

the beginning of every DMT symbol prior to transmission. This cyclic prefix has to be at least as long as the impulse response of the channel¹ to ensure orthogonality between the tones. In the receiver, this cyclic prefix is removed before the signal is demodulated by the FFT.

Since VDSL can be considered baseband communication, our DMT-modulator generates a real-valued signal, which for one symbol interval can be written as

$$x(t) = \sqrt{\frac{2}{N}} \sum_{k=0}^{N-1} \text{Re} \left\{ X_k e^{i \frac{2\pi k}{2N} f_s t} \right\}, \quad -\frac{CP}{f_s} \leq t < \frac{2N}{f_s} \quad (5.3)$$

where N is the number of DMT-tones, X_k is the data on tone k , and f_s is the sampling frequency. In the receiver the incoming signal, $y(t) = x(t) * h(t) + n(t)$, is sampled and then demodulated with an FFT

$$Y_k = \sum_{n=0}^{2N-1} y(n/f_s) e^{-i \frac{2\pi}{2N} kn}. \quad (5.4)$$

When the cyclic prefix is sufficiently long the DMT system is equivalent to N parallel independent channels, as illustrated Figure 5.3,

$$Y_k = X_k H_k + n_k, \quad (5.5)$$

where H_k is the transfer function on the frequency corresponding to subchannel k ,

$$H_k = \int_{-\infty}^{\infty} h(t) e^{-i \frac{2\pi k}{2N} t f_s} dt. \quad (5.6)$$

This is one of the big advantages with DMT: it makes equalization quite simple. Only a one-tap equalizer is needed for each DMT-tone

$$\hat{X}_k = \frac{Y_k}{H_k}. \quad (5.7)$$

To make efficient use of the available bandwidth, DMT systems use a technique called bit-loading [40] to adjust the size of the signal constellation on each tone according to the SNR on the corresponding tone. The stationary behavior of the wire-line channel allows for good channel estimates [75], and accurate synchronization [76]. This ensures that the high SNR that short wires offer can be fully exploited and constellation sizes of 10-12 bits (1024-4096

¹Not counting the pure delay part in the impulse response due to the propagation delay.

QAM) can be used in VDSL. Slow changes in the noise environment and the channel can occur though.

For channels with really long impulse responses, the normal DMT system can be complemented with a time-domain equalizer (TEQ) [77, 78, 79, 80]. The TEQ is designed to shorten the effective length of impulse response, so that a shorter cyclic prefix can be used. The overhead in cyclic prefix represents an efficiency loss, thus it is desirable to make the CP a smaller fraction of the DMT symbol. Another solution is to use a larger FFT-size (many tones), which makes the efficiency-loss due to the CP smaller. The current VDSL proposal has 4096 tones (8192-FFT) and a cyclic prefix that is 640 samples long, which results in 7.2% efficiency loss (for $f_s = 35.328$ MHz) [61].

The peak-to-average power ratio (PAR)[81] is believed to be a larger problem with DMT systems than with single-carrier systems. This is because the DMT signal exhibits a nearly Gaussian amplitude distribution in the time-domain. A system with high PAR requires larger dynamic range for the analog-to-digital converter (ADC) and the digital-to-analog converter (DAC) to avoid clipping [82, 83]. The linear region in the line-driver must also be larger. Considerable efforts have been directed at reducing the PAR for multicarrier systems [84, 85, 86, 81, 87]. For the VDSL proposal based on DMT and the Zipper duplex method (see the following section) it is believed that a 12 bit ADC is sufficient [88].

It has been argued that DMT-based VDSL systems would be much more complex than CAP-based VDSL systems, requiring larger chip-sizes and consuming much more power. If we consider only the modulation, a DMT system is more complex than a comparative CAP system because of the FFT-operation. But the equalization requires much more processing per symbol in a CAP system than in a DMT system (which requires only one multiply-and-add per symbol). If we consider a complete system with modulation/demodulation, equalization, symbol coding/decoding, interleaving, Reed-Solomon- and/or convolutional-coding, and the analog parts, then the overall complexity (chip-size and power consumption) will not be much larger for a DMT system than a comparative CAP system [89, 90]. The difference between a DMT system and a CAP system in terms of bit rate performance is not expected to be that big, but DMT might hold a slight advantage [45]. Theoretically the two systems can perform equally well [91, 92, 93], but parameters like length of cyclic extensions versus excess bandwidth can make a difference.

Being a multicarrier scheme DMT offers a certain amount of immunity against narrowband interference. If the interference is not too strong it will mostly affect just one or a few DMT-tones, and this can be compensated for with the bit-loading. Section 7 discusses the problem with radio frequency interference in more detail. Another advantage with DMT is that the transmit PSD can be shaped without difficulty to comply with the regulations for transmit power that can vary between different frequency bands. It also can be beneficial to have a spectrally shaped PSD when performing power back-off, which is discussed in Section 8.

5.3 Filter bank based modulation

Other types of multi-band communication schemes have also been proposed for VDSL. In [94] Sandberg and Tzannes propose discrete wavelet multitone (DWMT) modulation, and Cherubini has developed a similar scheme called filtered multitone (FMT) [95]. The common idea for both methods is to create a signal with better spectral containment than DMT. This facilitates the handling of the RFI problems. DWMT uses perfect reconstruction filter banks for modulation and demodulation. However, the filter banks are not perfect for a dispersive channel; thus it needs equalization over both time and frequency. The filter banks in FMT are designed to have close-to-zero spectral overlap between the sub-bands. The drawback is that it introduces ISI, so the structure requires an equalizer even for an ideal channel. But the equalization can

be made on a per sub-band basis as a result of the close-to-zero spectral overlap. This can be implemented with Tomlinson-Harashima precoding in the transmitter, which eliminates the risk for error propagation in the feedback section.

Chapter 6

Duplexing

Duplex transmission means transmission in two directions. To perform duplex transmission on one pair of wires, a duplex method or echo-cancellation is needed. To avoid the NEXT that otherwise can significantly limit the performance, VDSL needs to use some type of duplex method to share the bandwidth between the two transmission directions. In this section we will give a brief description of the two traditional duplex methods, namely time division duplex (TDD) and frequency division duplex (FDD). This is followed by a description of the Zipper duplex method. We will try to highlight the main characteristics and the pros and cons of each of the duplex methods.

It is not always advantageous to share the capacity of the channel in order to avoid the NEXT. Whenever the capacity, in a certain bandwidth, for a NEXT-limited system is larger than half the capacity for a FEXT (or background noise) limited system, a duplex method is not required. In that case a full duplex configuration where the bandwidth is not shared provides higher bit rate performance. A full duplex system does need an echo-canceller though, to reduce the near-echo that is usually much stronger than the NEXT [53, 96, 97].

6.1 Time Division Duplexing

One of the most natural ways to divide the wire-channel between upstream and downstream direction is to use time division duplexing. That is, the wire-channel is either used for downstream communication or for upstream communication, never in both directions at the same time. This is sometimes referred to as half-duplex. With TDD a silent guard time is required between change of transmission direction to let the signal from the other end propagate through the wire and fade out. This silent guard interval should be kept as small as possible to achieve high duplex efficiency.

TDD can be used with practically any modulation method, single carrier- as well as multicarrier- and filter bank based- modulation. To allow for some flexibility in the capacity division, a superframe structure of fixed length is usually established, consisting of a number of upstream symbols and a number of downstream symbols separated with a guard interval. The relative number of upstream and downstream symbols determines the capacity division and can easily be changed at runtime. Thus the ratio between the upstream and downstream data rates can be adjusted at any time. It should be remembered though that all modems that communicate through the same cable bundle must use the same superframe structure and upstream/downstream allocation [98, 99, 17].

One appealing feature with TDD is that the analog front end (AFE) becomes simpler than for other duplex methods. Since transmission and reception never take place at the same time there is no need for a hybrid and/or analog filters to reduce the power in the near-echoes.

The requirements on the ADC are lower since it only needs to be dimensioned to handle the dynamics in the received signal when there is no echo signal.

If it is desirable to give all users in a cable bundle the same ratio between upstream and downstream bit rates, TDD is a good choice of duplex method. On the other hand, if a mix of services is desired, where users on short wires have more asymmetrical rates than users on long wires, or vice-versa, a frequency divided system is preferable.

One drawback with TDD is that it can not use the spectrum below 2 MHz in an efficient way, due to compatibility issues with ADSL. Compatibility between VDSL and other systems is addressed in Section 9. Another disadvantage with TDD is that all modems in the network must be synchronized to each other to eliminate the NEXT. In an unbundled [100] environment this could be a problem, since the use of a common master-clock might not be feasible.

6.2 Frequency Division Duplexing

Frequency division duplexing (FDD) is the other classical duplex method. With FDD the bandwidth is divided into disjoint frequency bands, and each frequency band is used in either the upstream or downstream direction. Just as with TDD, FDD can be used with any type of modulation method. The standard for ADSL is based on FDD and DMT modulation [8, 9]. ADSL was designed solely for asymmetrical service, but VDSL shall be able to offer symmetrical as well as asymmetrical services.

The major advantages with FDD are that it requires no system-wide synchronization of the modems, and together with CAP modulation it can offer a simple solution [101]. However, a simple implementation comes with limited flexibility when it comes to sharing the capacity and it is difficult to reconfigure the modems after installation. Once the number of frequency bands is set it cannot be changed, and if the width and position of the frequency bands are to change then the analog filters that separate them must be tunable. The guardbands between the up- and downstream bands constitute an efficiency loss, and to reduce that loss the band-pass filters need to be quite steep.

For VDSL it is desirable to use more than one frequency band in each duplex direction. The reason for this is that there is a large variation in usable frequency range for modems on different wire lengths. A modem on a 1500m line can only use around 3 MHz bandwidth, whereas a modem on a 300m long line can use more than 15 MHz. To guarantee that all users get satisfactory performance at least two frequency bands in each duplex direction is recommended [61]. With increasing number of frequency bands the complexity of an FDD system increases also. An FDD system needs a complete transmitter-receiver structure: modulator, demodulator, equalizer, filters etc., for each frequency band.

6.3 Zipper

The Zipper duplex method [102, 103, 104, 105] is a recent duplexing technique based on an idea from Mikael Isaksson at Telia Research in Luleå. It is specific to DMT modulation and divides the bandwidth by assigning different tones to the upstream and the downstream directions, see Figure 6.1. For example, if symmetrical bit rates are desired every other tone can be assigned to opposite directions; it is from this configuration that Zipper lends it name. To ensure orthogonality between the upstream and downstream signals, all modems in a Zipper system must be synchronized (similarly to TDD) so that transmission of new DMT frames start simultaneously in all modems. Further, to compensate for the propagation delay in the wires Zipper needs an additional cyclic extension, which is called a cyclic suffix (CS). The length of this cyclic suffix should be at least as long as the propagation-delay in the longest wire used in

the VDSL system.

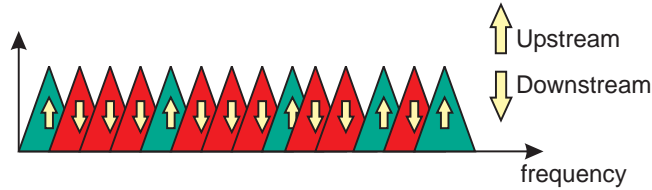

Figure 6.1: The Zipper principle.

The key advantage with Zipper is perhaps the flexibility it offers. A Zipper system can in a general sense be thought of as an FDD system with a very large number of frequency bands (4096 in the current standards proposal). However, the different bands are not disjoint in frequency, they are overlapping in frequency but mathematically orthogonal to each other. This very large set of tones (frequency bands) can at run-time be repartitioned in any possible way to divide the capacity between upstream and downstream direction. By choosing different tone-allocations, almost any ratio between upstream and downstream bit rates can be achieved. The bit rate ratio can also be made wire length dependent as well as length independent if needed [106]. Since the tone-allocation can easily be changed during the day, Zipper can better accommodate the different traffic loads that VDSL systems can experience. As the type of services that subscribers use changes during the day the bit rate ratio might also change. Like traditional FDD, Zipper can also be made spectrally compatible with ADSL [107, 103, 108] (see Section 9). Figure 6.2 shows a comparison of TDD, FDD, and Zipper using a time-frequency grid.

A disadvantage Zipper shares with TDD, is the system-wide synchronization that is required to avoid NEXT. However, a variant of Zipper called asynchronous Zipper, can operate without synchronization of all modems [109, 110]. This is accomplished by grouping the tones used in the same direction into larger frequency bands, and by implementing non-rectangular windowing in the receiver and transmitter [111] that lowers the side-lobe leakage of the tones. But to maintain the orthogonality between the tones the effective windowing has to be performed on additional cyclic extensions, see Figures 6.3 and 6.4. The receiver window must have the same symmetrical properties in the time-domain as is required in the frequency domain for a transmit-pulse fulfilling the Nyquist criterion for ISI-free transmission. Instead of calculating a $2N$ -point DFT of the $2N + \mu$ samples, the pulse-shaped wings are cut off and added to the other side of the symbol as illustrated in Figure 6.4. By doing this cut-and-add trick, a $2N$ -point FFT can be used instead. Nevertheless, there is a small performance loss with asynchronous Zipper due to remaining non-orthogonal NEXT. Another solution, which does not result in any performance loss, is to implement an algorithm for autonomous self-synchronization of the modems [112]. Such a synchronization method could likely be used with TDD also.

A traditional FDD system uses analog filters to separate the signals going in opposite directions. But this limits the flexibility of the bandwidth assignment, thus it is preferably not used with Zipper. However, without analog filters the AFE must be dimensioned to handle the dynamics in the near-echo as well as the desired signal from the far-end [113]. One consequence of this is that more bits might be required in the ADC, but this problem can be reduced with adaptive hybrids and PAR-reduction methods.

Another attractive feature with Zipper is that it can use full duplex on some of the tones. The NEXT-coupling is quite small at the lower frequencies, so the capacity can be increased if the lower frequencies are used in both transmission directions; this is an option in ADSL also. However, full duplex transmission requires echo-cancellation to remove the own transmitted

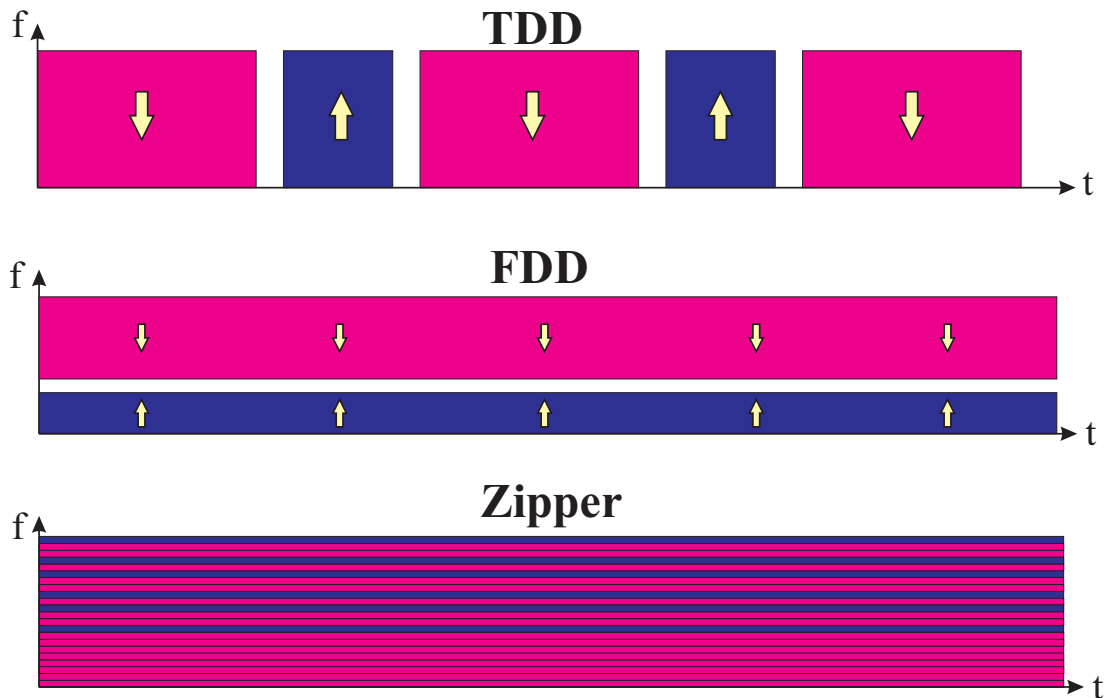

Figure 6.2: Illustration of TDD, FDD, and Zipper on a time-frequency grid. The darker color represents upstream direction.

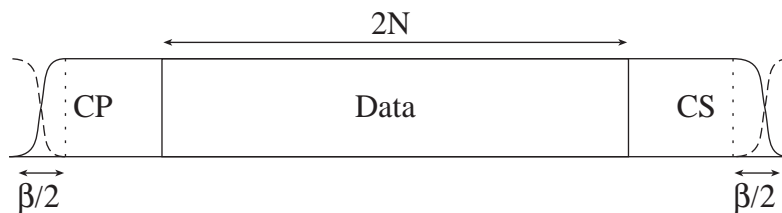

Figure 6.3: Pulse-shaping in the transmitter.

signal from the received signal [96, 97]. An echo-canceller is generally considered to be quite complex, but this is very simple if the Zipper duplex method is used. Since the synchronization and the cyclic suffix ensure orthogonality of both the upstream and downstream signal the echo-cancellation can be made in the frequency domain (similar to equalization) and requires only one multiply-and-add operation per tone.

There are also other future VDSL-boosting techniques that are simpler to implement if Zipper is used. If the VDSL modems are coordinated at the central office, more advanced methods like NEXT-cancellation, vectoring, and multi-user detection can be used to increase the performance. If a NEXT-canceller is implemented the whole bandwidth can be used in both directions at the same time and thereby the transmission capacity can practically be double. A NEXT-canceller operates in principle in the same way as an echo-canceller does. Every NEXT-coupling path into a modem can be seen as an echo path. Thus all mutual NEXT-couplings between all modems must be identified, and the NEXT that every modem will receive has to be calculated. For a Zipper system this can be made on a per-tone basis, which simplifies the implementation. For N VDSL systems the NEXT-cancellation requires $N - 1$ multiply-and-add's per user and tone. There are also ways to reduce the FEXT. In the

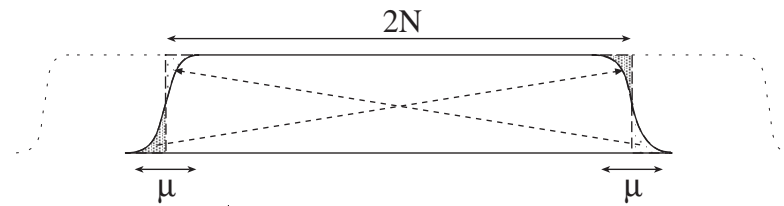

Figure 6.4: Windowing in the receiver.

upstream, multiuser detection can be used in the central office. For example, a generalized decision feedback equalizer could be used [92]. For the downstream a vectorized transmission scheme has been proposed to reduce the FEXT [114]. By identifying every FEXT-coupling the data can be precoded at the central office in such way that the FEXT cancels out itself at the customer side. The complexity of NEXT- and FEXT-cancellers is quite large and it is not likely that this will be implemented in early generations of VDSL. However, these type of VDSL-boosters might be feasible in the future and can prolong the life span of VDSL since they can increase total capacity significantly.

Zipper is also referred to as digital duplexing [115] and can be generalized to duplexing using any set of orthogonal waveforms. The key-concept is that orthogonal (or nearly orthogonal) waveforms should be used in the upstream and the downstream. However, care has to be taken in designing the waveforms since one of the two received signals is always delayed. Two possible choices of other modulation methods than DMT that can be used with the Zipper concept are FMT [95] and DWMT [94].

Chapter 7

Dealing with Radio Frequency Interference

Radio frequency interference is a mutual problem between VDSL systems and other users of the radio frequency spectrum. In our context RFI-ingress refers to the interference VDSL receives from radio signals, and RFI-egress represents the radio signal that a VDSL modem generates that can disturb HAM-radio users for example. This section will discuss different methods for dealing with the RFI problems. The focus is on methods for DMT-based system, but single carriers systems are also discussed.

7.1 RFI Egress

Just as HAM-radio users are considered to be the largest potential threat to VDSL systems when it comes to generating severe RFI, HAM-radio users are the ones who are most likely to be disturbed by RFI-egress from VDSL system. The amateur radio users have very sensitive receivers and are allowed to use frequencies higher up in the spectrum than AM-broadcast transmitters. The wire-line is less well-balanced at higher frequencies and therefore the RFI-egress is larger for higher frequencies. In a study at BT [47] it was concluded that in order to not disturb amateur radio users, the transmit PSD for VDSL should not exceed -80 dBm/Hz (20 dB lower than the nominal -60 dBm/Hz) in the recognized amateur radio bands, see Table 4.1. This was based on analytical results as well as field tests.

For a single carrier system these notches in the transmit spectrum can be created with either digital or analog filters in the transmitter, or a combination of both. But to create steep notches quite complex filters with long impulse responses are required. One solution for systems using FDD, which simplifies the filter construction, is to let the edges of the frequency bands coincide with the HAM bands.

For a DMT system the PSD-notches in the HAM bands can be created by simply silencing some of the tones, or at least reducing the transmit PSD. But due to sidelobe leakage of the DMT-tones, not only the tones within the HAM bands have to be silenced, but a number of tones outside the HAM bands must also be zeroed. The more tones the DMT system uses the less the efficiency loss will be. A method proposed by Bingham *et al.* [116, 117] uses one or two dummy tones at the edges of a HAM band and modulates them so that deeper notches are created within the HAM band. A non-rectangular transmit window (as in Figure 6.3) can also help create deeper notches. Combining the two approaches offers a very good solution [118].

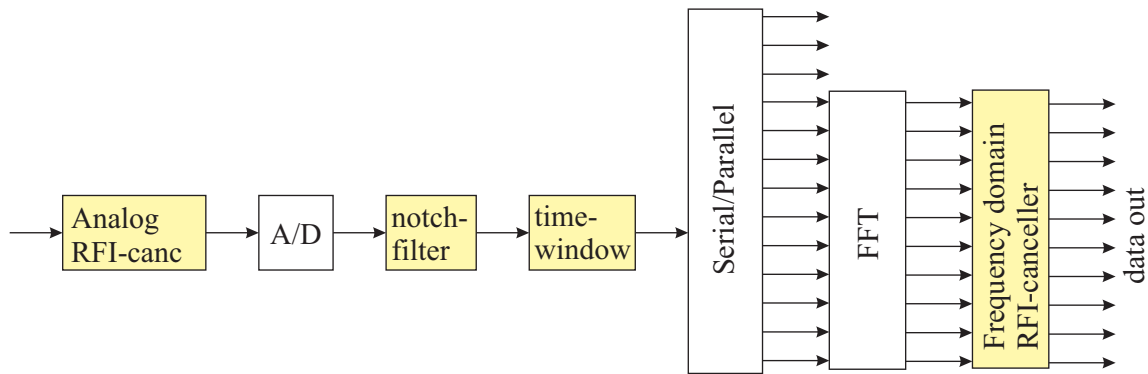

Figure 7.1: Examples on different RFI-cancellers.

7.2 RFI Ingress

The RFI can be suppressed both in the analog domain and in the digital domain. It might even be necessary to use both an analog and a digital canceller to cope with the worst kind of RFI. Even if it is possible to completely eliminate the RFI with digital signal processing, the RFI signal can be so strong that it causes problems in the analog front-end (AFE) and saturates the ADC. Figure 7.1 shows examples of where different types of RFI-cancellers can be applied in a VDSL receiver that uses DMT.

In the analog domain one can either use a tunable notch filter or a noise canceller [119, 118]. The noise canceller, is probably the best choice since a notch filter has very long impulse response. For a DMT system this means that the length of the cyclic extension must be longer to preserve the orthogonality. By using the common mode signal as reference signal and a simple adaptive filter that adjusts the phase and gain of the common mode signal, most of the differential mode RFI signal can be subtracted away. The RFI can be suppressed up to 30 dB with this type of noise canceller [118], which usually is enough to avoid saturation of the ADC.

In the digital domain different RFI-suppression methods exist for different modulation methods. One suppression method that can be used for any type of modulation-scheme is an adaptive notch-filter. However, for the same reason an analog notch filter is not suitable, the corresponding impulse response of a digital notch filter also has a very long tail. In single-carrier systems the feed-forward and feedback sections of the DFE can be designed to deal with the RFI. However, the filters might have to be rather long and the adaptation of the filters must be capable of handling the case when an amateur radio user transmits Morse signals. Another option is to use a noise-predictive DFE where a noise predictive filter is used to cancel the RFI [45]. This can simplify the design of the feed-forward and feedback filters.

Multicarrier systems are often considered to be more robust against narrowband interference, since the noise is concentrated to a few tones and can be handled by the bitloading algorithm. This is true for moderately strong narrowband interference, like RFI from AM, but for very strong RFI signals a DMT system can suffer just as much as a single-carrier system. The side-lobe leakage decreases as $1/f$, which means that the PSD drops very fast near the center of the RFI, but farther away the RFI does not fall off as fast. This is due to the rectangular receiver window that is used in a traditional DMT system. One method to reduce the RFI that was proposed by Alcatel is to use a non-rectangular receiver window [111]. With asynchronous Zipper the windowing is already an inherent part of the VDSL system. Even though a non-rectangular window can suppress the RFI on many of the tones, the tones closest to the RFI still receive a considerable amount of RFI, see Figure 7.2.

One very promising idea for RFI-suppression, initially proposed by Bingham, is to use a

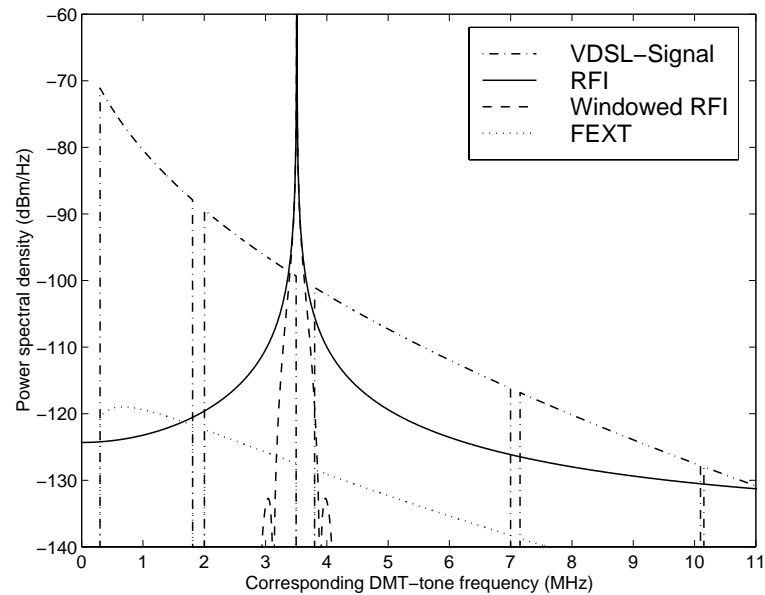

Figure 7.2: RFI in the frequency domain after the FFT, with and without windowing in the time-domain. The received VDSL signal and VDSL self-FEXT are also shown.

small number of unmodulated tones to measure the RFI and then estimate the parameters in a parameterized model of the RFI [120, 121]. The parameterized model can be derived with a Taylor expansion of the complex envelope of the RF signal, for example. The RFI can then be extrapolated to all DMT-tones and subtracted away. Improved versions using more general models have later been developed [122, 123, 124, 125]. In [125] it is shown that two parameters are sufficient to provide good performance, which means that only two measurement tones are needed. This technique can be combined with windowing in the time-domain, which reduces the complexity since a smaller number of tones need to be processed by the canceller.

Chapter 8

Power Back-Off

If all users in an access network transmit at the maximal allowed PSD level we could have a problem in the VDSL system similar to the near-far problem experienced in CDMA systems [126]. Modems on short wires will create much stronger FEXT than modems on long wires. This can be called a near-far FEXT problem. The consequence of near-far FEXT is that when the users are distributed along a cable, as in Figure 8.1, those furthest away from the central office may have almost no bit rate capacity in the upstream. Figure 8.2 shows the achievable bit rates¹ for the different users in the scenario from Figure 8.1 when all modems use maximal allowed transmit PSD. One can see that the upstream bit rates drop much faster with increasing distance than the downstream bit rates. This due to the near-far FEXT problem.

To solve the near-far FEXT problem in VDSL a number of different power back-off methods have been proposed [127, 128, 129, 130, 131]. The concept of power back-off is that modems on short wires should use lower transmit power and thus create less FEXT. This is similar to power control in CDMA, but in VDSL one has the opportunity to perform frequency-dependent power back-off. Furthermore power back-off in VDSL is used to ensure more even bit rate levels between the users, not more equal bit error rates as is the case normally in CDMA.

Many different power back-off methods have been proposed to solve the near-far problem, some more ad-hoc than others. The constant power back-off method is a method that does not create a spectrally shaped transmit PSD [128]. The transmit PSD is simply set to a fixed level, and shorter wires lower their PSD-level more. A special case of constant power back-off is the so-called reference frequency method [128]. With this method the transmit PSD is lowered so that the PSD of the received signal, at a certain *reference frequency* (typically between 1 and 3 MHz) is the same for all wires.

Another back-off method proposed in [128] is the reference length method. With the reference length method, the aim is to set the transmit PSD of every user so that the PSD of the received signal is the same as that received from a modem at the *reference length*. This creates a frequency dependent transmit PSD, which is easily attained with DMT modulation.

¹The rates for this example represent simplex transmission: that is the achievable bit rates if you transmit in either the downstream or the upstream direction, but not both.

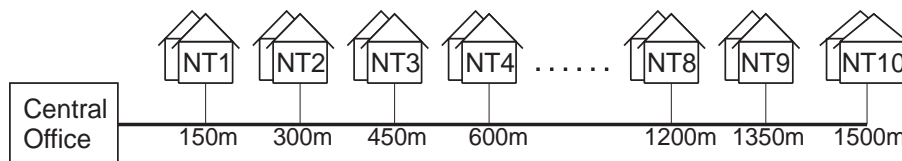

Figure 8.1: Distributed cable topology.

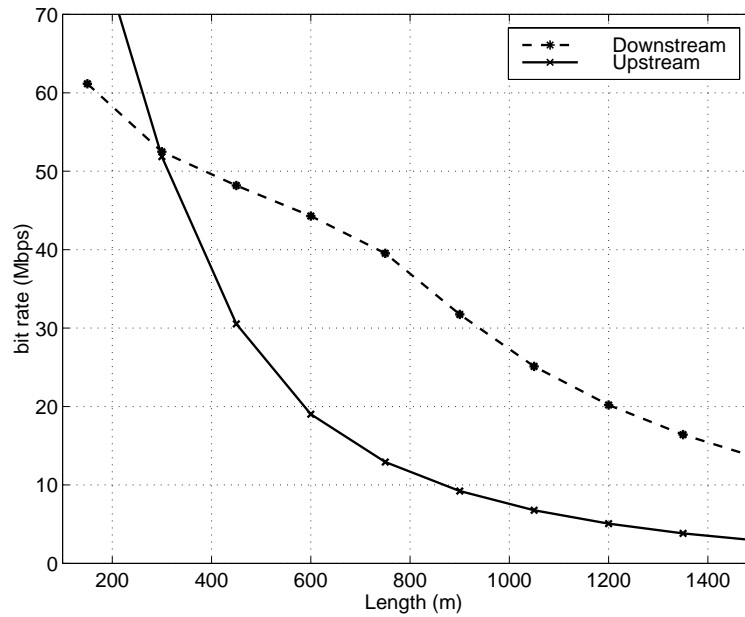

Figure 8.2: Example of simplex bit rates in up- and down-stream when full transmit power is used, for the scenario in Figure 20.

Characteristic of the reference length method is that the bit rates are almost constant for all wires lengths up to the reference lengths, but for longer wires the capacity drops very quickly. The drawback with this is that in most cases, modems on the shortest wires could increase their transmit PSD, and consequently their bit rates, without penalizing the users on the long wires much at all. A modified version of the reference length method is the multiple reference length method [132]. With that method different reference lengths are used for different parts of the spectrum. This helps overcome the drawback that the reference length method has with too low bit rates for users on very short wires. The equalized FEXT method [131] is another method closely related to the reference length method. The goal with the reference FEXT method is that the FEXT received on any wire should always look as it comes from a modem on a reference length.

Two closely related methods are the reference noise method [130] and the multi-rate method [127]. Both methods generate a spectrally shaped transmit PSD, such that the color of the FEXT is the same as the color of the background noise. An intuitive explanation of why this is desirable is that in this case the background noise can mask the FEXT.

One drawback with many of the methods is that they are based on one single system-wide design parameter, and hence cannot control the ratio between upstream and downstream. This means that a system operator is limited in its ability to control what bit rates can be offered to different users. The multiple reference length method and the multi-rate method are the only methods that address this issue.

It should be mentioned that power back-off can also be used in the downstream, but the change in bit rate distribution will not be as dramatic as for the upstream [128]. In the upstream power back-off decreases the bit rate for a few users on short wires, but it increases the bit rate for a larger number of users on long wires.

Chapter 9

Spectral Compatibility

For the deployment of VDSL it is important that already existing services are not disturbed, or at least affected as little as possible. Existing services can be POTS, ISDN, HDSL, and ADSL and also new home-network systems using the telephone lines (HPNA). A reasonable condition for coexistence is that the mutual crosstalk should be kept to a minimum. Since the NEXT-coupling is always larger than the FEXT-coupling it is most important to avoid NEXT between the systems.

9.1 POTS and ISDN

Like ADSL, VDSL is required to coexist on the same line as POTS or ISDN. The services VDSL offer today cannot replace the ordinary phone service. The main reason why VDSL cannot replace POTS and ISDN today is the lifeline service. The ordinary phone is powered via the line and can function even in case of a power failure. To power the VDSL modem via the line and provide battery backup in case of power failure is not feasible since the power consumption is too large. However, for future generations of VDSL an in-band POTS-service could be possible [133]. The use of in-band POTS would also decrease the amount of impulse noise in the network.

Both POTS and ISDN occupy quite small bandwidth, so the compatibility is solved by having VDSL avoid the part of the spectrum occupied by POTS or ISDN. This means that VDSL does not transmit below 30 kHz for POTS and below 300 kHz for ISDN. When VDSL is installed a so-called POTS/ISDN-splitter [134] is also installed, see Figure 9.1. This is a three-port network consisting of bi-directional filters separating the low-frequency POTS/ISDN-traffic from the high-pass VDSL traffic.

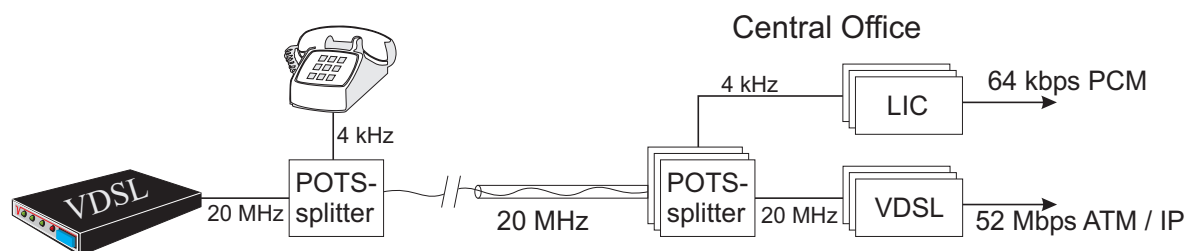

Figure 9.1: VDSL configuration with POTS-splitter separating the VDSL traffic from the POTS traffic.

9.2 HDSL

HDSL is a full-duplex system using echo-cancellation. This means that it occupies the same frequency range for both the upstream and downstream. The only way VDSL can avoid NEXT, to and from HDSL, is to not use the frequency range occupied by HDSL. According to the European standard HDSL can operate on 1, 2 or 3 wire-pairs, and the symbol rate is 392 kHz for a three-pair configuration. If one considers HDSL's side-lobes it can create crosstalk in a much larger frequency range.

The crosstalk problem will be bigger from HDSL into VDSL, since HDSL can use a much higher transmit PSD (-38 dBm/Hz), than VDSL (nominally -60 dBm/Hz). This means that VDSL can use the same frequencies as HDSL without creating too much NEXT into HDSL, at least for a central office based scenario. The strong crosstalk from HDSL into VDSL will of course be a problem. But since HDSL occupies a quite large frequency range, a considerable amount of valuable bandwidth would be lost if VDSL positioned its frequency band above HDSL. In a cabinet-scenario it can also be important to consider VDSL crosstalk into HDSL (the cabinet-scenario is addressed in the subsection below).

9.3 ADSL

It is perhaps most important to consider the coexistence between ADSL and VDSL. ADSL uses a larger bandwidth than HDSL and POTS/ISDN, and the number of ADSL systems in the network is likely to be larger than for HDSL. ADSL is a frequency divided system and transmits predominantly in the downstream direction. The upstream band for ADSL is located at the lower frequencies and ends at 138 kHz. The downstream band ranges from 138 kHz to 1104 kHz. There exists an option for overlapping upstream and downstream band also, where the downstream band starts at 30 kHz, but this requires echo-cancellation.

The compatibility issue between ADSL and VDSL has been discussed in many standardization contributions [107, 135, 136, 137, 138]. If VDSL transmits downstream in ADSL's downstream band (138-1104 kHz) NEXT is avoided between the systems. The current frequency plan by ETSI [61] is designed with that in mind, and has a downstream band located at ADSL's downstream frequency range (see Table 9.1 below). ADSL can use -39.5 dBm/Hz transmit PSD, which makes ADSL crosstalk into VDSL a larger problem than the other way around. There is an option in the standards for a boosted PSD-mask for VDSL, which allows it to use higher PSD-levels in the ADSL band [15, 14]. This can be used to reduce the effect of the strong FEXT from ADSL in a CO-scenario where VDSL is installed at the same location as the ADSL systems. Figure 9.2 illustrates another scenario where VDSL is installed in the cabinet. This can create the reversed crosstalk problem, where VDSL disturbs ADSL more. The VDSL specifications [15, 14] include a reduced PSD-mask that should be used for this type of scenario. This might be needed in order to avoid strong FEXT from VDSL into ADSL.

The discussion above tells us that a frequency divided system, e.g. FDD or Zipper, is needed for best coexistence between VDSL and ADSL. A TDD system would suffer more from ADSL crosstalk since the upstream transmission would experience NEXT in the ADSL downstream band, and it is not certain that TDD systems would be allowed to transmit upstream in the ADSL downstream band. Furthermore, Zipper can offer interoperability between VDSL and ADSL. By selecting the frame-length and tone-width of the VDSL system properly (equal to those of ADSL), the VDSL modem could also operate as an ADSL modem.

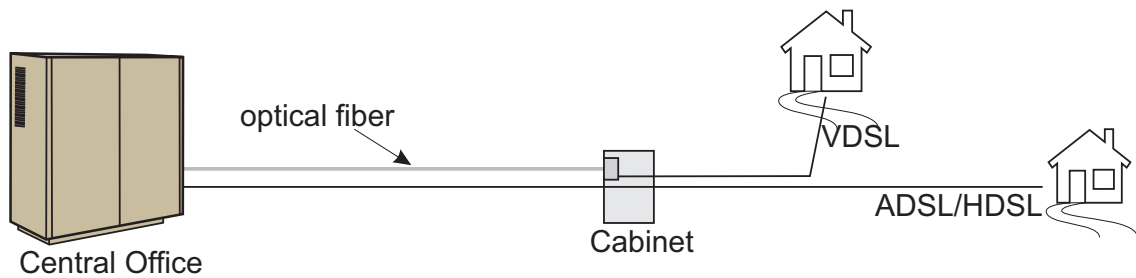

Figure 9.2: Scenario where VDSL is delivered from the cabinet and ADSL/HDSL from the central office.

9.4 HPNA

A recent problem for VDSL is the entry of in-house network communication systems, such as those defined by the Home Phoneline Networking Alliance (HPNA) [139]. So far these types of systems have only reached the market in North America, but they might soon show up in Europe and Asia too. The HPNA-adapters use a spectrum from roughly 4 MHz to 10 MHz and a PSD-level of -70 dBm/Hz [140]. If one user wants to have both VDSL and HPNA this can be solved by the POTS-splitter [134]. With the POTS-splitter, the VDSL signal will be filtered away, not reaching the in-house wiring intended for POTS and HPNA. Further, the HPNA signal will never reach the VDSL modem either. Without this splitter VDSL and HPNA will disturb each other too much for either system to work properly.

If HPNA is used without a filter on the incoming line, this can disturb VDSL modems on neighboring lines through NEXT and FEXT couplings. This compatibility problem can not be solved with frequency planning. If VDSL transmits downstream in the frequency range occupied by HPNA it is disturbed by NEXT from HPNA, and if VDSL transmits upstream in HPNA band, HPNA is disturbed by NEXT from VDSL. The use of multiuser detection and soft cancellation have been proposed as counter measures for HPNA crosstalk [141, 140]. Probably a less complex solution is to have the HPNA-users install filters that prevents crosstalk from the telephone line entering the indoor wiring, and vice-versa. However, filter installation would require the use of service personnel, which can be costly.

9.5 Frequency Plans

The current technical specifications for VDSL by ANSI and ETSI [14, 15] prescribes a frequency divided system. The TDD-proposal was ruled out because of the synchronization requirements. The Zipper duplex method can operate in an asynchronous mode and is also a candidate for the VDSL standard.

A considerable amount of engineering work has been done to find a universal band allocation (UBA) for VDSL. Deregulation of the telecommunication market and unbundling of the cables have been a driving incentive for a universal band allocation. If modems from different vendors should be compatible with each other and if modems on different wires are not to cause NEXT to each other, a common frequency plan has to be agreed upon. The number of bands used in each transmission direction and the location of them are directly related to the range of bit rates services that can be offered to the subscribers. For a traditional FDD system, a modem cannot easily be constructed to accommodate any possible frequency plan or a variable number of frequency bands, but that flexibility comes with no extra cost with the Zipper duplex method.

What complicates the matter of finding the universal band allocation is that nobody knows

Table 9.1: Frequency plans according to ETSI specifications.

Default plan		Optional Plan	
Downstream	Upstream	Downstream	Upstream
0.138-3.0 MHz	3.0-5.1 MHz	0.138-3.75 MHz	3.75-5.2 MHz
5.1-7.05 MHz	7.05-12 MHz	5.2-8.5 MHz	8.5-12 MHz

what types of services the customer will want in the future, and operators around the world have different opinions about this. It is also hard to find a compromise plan that can provide fair performance for both symmetrical and asymmetrical services. The latest technical specifications from ETSI [61] include one default frequency plan and one optional plan to satisfy alternative regional requirements. Both plans have two upstream and two downstream bands between 138 kHz and 12 MHz, see Table 9.1.

If the Zipper duplex method is used only one default plan is needed, and then the operators are free to agree upon any optional plan that better can suite the regional requirements. If one operator owns all wires in a cable that operator has full freedom to choose any frequency plan at any time, to satisfy the subscribers in the best possible way.

Appendix A

Transmission Line Characteristics

In this appendix we will derive the transfer function of a transmission line, and analyze the effect of a bridged tap. By using Kirchhoff's laws for the circuit in Figure 3.1 and letting Δx go to zero we get two first order differential equations

$$-\frac{\partial V(x,t)}{\partial x} = RI(x,t) + \frac{\partial I(x,t)}{\partial t}L \quad (\text{A.1})$$

$$-\frac{\partial I(x,t)}{\partial x} = GV(x,t) + \frac{\partial V(x,t)}{\partial t}C \quad (\text{A.2})$$

Consider an arbitrary sinusoidal signal with frequency f . This yields the following steady state solutions

$$-\frac{dV(x)}{dx} = (R + j2\pi fL)I(x) \quad (\text{A.3})$$

$$-\frac{dI(x)}{dx} = (G + j2\pi fC)V(x). \quad (\text{A.4})$$

These coupled differential equations can be separated and rewritten as second order de-coupled equations

$$\frac{d^2V(x)}{dx^2} = \gamma^2V(x) \quad (\text{A.5})$$

$$\frac{d^2I(x)}{dx^2} = \gamma^2I(x), \quad (\text{A.6})$$

where the *propagation constant* γ , which is frequency dependent, is defined as

$$\gamma(f) = \sqrt{(R + j2\pi fL)(G + j2\pi fC)}. \quad (\text{A.7})$$

The solutions to the differential equations in (A.5) and (A.6) are

$$\begin{aligned} V(x) &= V_0^+ e^{-\gamma x} + V_0^- e^{\gamma x} \\ I(x) &= I_0^+ e^{-\gamma x} + I_0^- e^{\gamma x}. \end{aligned} \quad (\text{A.8})$$

This represents one wave going in the positive x -direction and one wave going in the reverse direction. The ratio between the voltage and current going in each direction is related through

$$\frac{V_0^+}{I_0^+} = -\frac{V_0^-}{I_0^-} = Z_0, \quad (\text{A.9})$$

where Z_0 is the *characteristic impedance* of the line, which is defined as

$$Z_0 = \sqrt{\frac{R + j2\pi fL}{G + j2\pi fC}}. \quad (\text{A.10})$$

Now we are interested in what happens when the line is connected to a source V_S with impedance Z_s and terminated with a load impedance Z_L . This is illustrated in Figure 3.2 where the transmission line is modelled as a two-port linear circuit with ABCD-parameter description [22]. If the length of the line is d we have $V_L = V(d)$, and $I_L = I(d)$ from (A.8) and we can solve for V_0^+ and V_0^- . Using $V_L = Z_L I_L$ we get the following solution

$$\begin{aligned} V_0^+ &= \frac{1}{2} (V_L + I_L Z_0) e^{\gamma d} \\ V_0^- &= \frac{1}{2} (V_L - I_L Z_0) e^{-\gamma d}. \end{aligned} \quad (\text{A.11})$$

The line is said to be perfectly terminated when Z_L equals the impedance of the line Z_0 . We can see from (A.11) that this gives $V_0^- = 0$, thus the wave going in the negative direction vanishes. From equation (A.8) one get the voltage V_i and current I_i at the input of the ABCD-network as $V_i = V(0) = V_0^+ + V_0^-$ and $I_i = I_0^+ + I_0^-$, which allows us to setup the ABCD-description of the circuit with matrix notation

$$\begin{bmatrix} V_i \\ I_i \end{bmatrix} = \begin{bmatrix} \cosh(\gamma d) & Z_0 \sinh(\gamma d) \\ \frac{1}{Z_0} \sinh(\gamma d) & \cosh(\gamma d) \end{bmatrix} \begin{bmatrix} V_L \\ I_L \end{bmatrix}. \quad (\text{A.12})$$

The ABCD-description is very convenient for cascade-coupled networks. The matrix representing the total system Φ is simply the product of the individual networks matrices Φ_n ,

$$\begin{bmatrix} V_0 \\ I_0 \end{bmatrix} = \Phi \begin{bmatrix} V_N \\ I_N \end{bmatrix} = \Phi_1 \Phi_2 \cdots \Phi_N \begin{bmatrix} V_N \\ I_N \end{bmatrix}. \quad (\text{A.13})$$

This is useful for analyzing bridged taps and the case where the line consists of several connected line-segments having different transmission characteristics (gauge, insulation etc.).

The ratio between the input voltage and the load voltage

$$T(f, d) = \frac{V_L}{V_i} = \frac{1}{\cosh(\gamma d) + \frac{Z_0}{Z_L} \sinh(\gamma d)} \quad (\text{A.14})$$

is of interest when we want to calculate the transfer function of the system. The transfer function is the ratio between the input and output voltage

$$H(f, d) = \frac{V_L}{V_S} = \frac{V_L}{V_i} \frac{V_i}{V_S} = \frac{Z_i}{Z_i + Z_s} T(f, d), \quad (\text{A.15})$$

where Z_i is the impedance of the terminated line (with Z_L) and can be derived from (A.12) as

$$Z_i = \frac{V_i}{I_i} = Z_0 \frac{Z_L + Z_0 \tanh(\gamma d)}{Z_0 + Z_L \tanh(\gamma d)}. \quad (\text{A.16})$$

When the line is infinitely long, or if it is perfectly terminated, we find that $Z_i = Z_0 = Z_L$. If the both the source impedance Z_s and the load impedance Z_L is matched to the characteristic impedance Z_0 the transfer function reduces to

$$H(f, d) = \frac{1}{2} T(f, d) = \frac{1}{2} \frac{1}{\cosh(\gamma d) + \sinh(\gamma d)} = \frac{1}{2} e^{-d\gamma(f)} \quad (\text{A.17})$$

A.1 Bridged Taps

To derive a model for a wire-line with a bridged tap one can view the whole line as a concatenation of three parts; the line before the bridged tap, the bridged tap itself and the line after the bridged tap, see Figure A.1. By considering the bridged tap itself as an impedance between the two wires [5], the ABCD-model of that is given by

$$\Phi_{BT} = \begin{bmatrix} 1 & 0 \\ \frac{1}{Z_{0,BT}} \tanh(\gamma_{BT} d_{BT}) & 1 \end{bmatrix} \quad (\text{A.18})$$

Thus overall ABCD-representation of line with a bridged tap will be

$$\begin{aligned} \begin{bmatrix} V_i \\ I_i \end{bmatrix} &= \Phi_1 \Phi_{BT} \Phi_2 \begin{bmatrix} V_L \\ I_L \end{bmatrix} \\ &= \begin{bmatrix} \cosh(\gamma_1 d_1) & Z_{0,1} \sinh(\gamma_1 d_1) \\ \frac{\sinh(\gamma_1 d_1)}{Z_{0,1}} & \cosh(\gamma_1 d_1) \end{bmatrix} \begin{bmatrix} 1 & 0 \\ \frac{\tanh(\gamma_{BT} d_{BT})}{Z_{0,BT}} & 1 \end{bmatrix} \begin{bmatrix} \cosh(\gamma_2 d_2) & Z_{0,2} \sinh(\gamma_2 d_2) \\ \frac{\sinh(\gamma_2 d_2)}{Z_{0,2}} & \cosh(\gamma_2 d_2) \end{bmatrix} \begin{bmatrix} V_L \\ I_L \end{bmatrix} \end{aligned} \quad (\text{A.19})$$

For a case where all the sections of the wire-line with the bridged tap consist of the same type of wire and the source and load impedance is matched to the characteristic impedance, the insertion loss will be:

$$T_{IL}(f) = \frac{Z_S + Z_L}{Z_L} H(f, d) = \frac{Z_S + Z_L}{Z_L} \frac{Z_i}{Z_i + Z_s} \frac{V_L}{V_i} \quad (\text{A.20})$$

$$= \frac{e^{-\gamma d}}{\left(1 + \frac{1}{2} \tanh \gamma d_{BT}\right)}, \quad (\text{A.21})$$

where $d = d_1 + d_2$ is the total length of the wire from the central office to the customer.

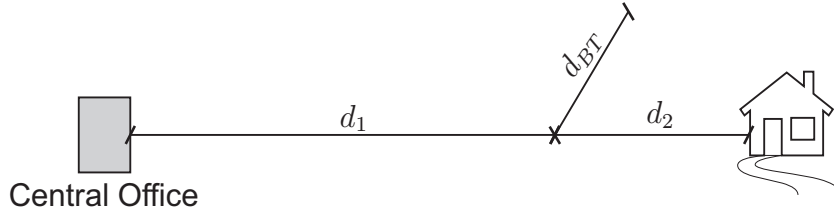

Figure A.1: A bridged tap.

Appendix B

RLCG-parameters

The RLCG-parameters of a twisted-pair wire are frequency-dependent, but quite accurate models have been derived by applying different types of curve-fitting to measured data. The following models are adopted by both ANSI [14] and ETSI [15]:

$$\begin{aligned}R(f) &= \sqrt[4]{r_{0c}^4 + a_c f^2} \\L(f) &= \frac{l_0 + l_\infty \left(\frac{f}{f_m}\right)^b}{1 + \left(\frac{f}{f_m}\right)^b} \\C(f) &= c_\infty + c_0 f^{-c_e} \\G(f) &= g_0 f^{g_e}\end{aligned}\tag{B.1}$$

Table B.1 lists the parameters for three different types of wire used by ANSI and ETSI. TP1 represents a 0.4 mm (diameter) or a 26-gauge twisted-pair phone-line, and TP2 represents a 0.5 mm or a 24-gauge wire [14]. The DWUG-wire also represents a 0.5 mm wire [15].

Table B.1: Parameters for curve-fitting of RLCG-parameters.

	TP1 ($\emptyset 0.4\text{mm}$)	TP2 ($\emptyset 0.5\text{mm}$)	DWUG ($\emptyset 0.5\text{mm}$)
Resistance			
r_{0c}	286.17578 Ω/km	174.55888 Ω/km	179 Ω/km
a_c	0.1476962	0.053073481	0.03589
Inductance			
l_0	675.36888 $\mu\text{H}/\text{km}$	617.29539 $\mu\text{H}/\text{km}$	695 $\mu\text{H}/\text{km}$
l_∞	488.95186 $\mu\text{H}/\text{km}$	478.97099 $\mu\text{H}/\text{km}$	585 $\mu\text{H}/\text{km}$
b	0.92930728	1.1529766	1.2
f_m	806.33863 kHz	553.760 kHz	1000 kHz
Capacitance			
c_∞	49 nF/km	50 nF/km	55 nF/km
c_0	0.0 nF/km	0.0 nF/km	1.0 nF/km
c_e	0.0	0.0	0.1
Conductance			
g_0	43 nS/km	234.87476 fS/km	500 pS/km
g_e	0.70	1.38	1.033

Appendix C

Alien crosstalk

Crosstalk from other types of systems is often referred to as alien crosstalk. For VDSL, crosstalk from ADSL, HDSL and ISDN is considered to be alien crosstalk and together with AWGN part of the background noise. The VDSL system requirements defined by ANSI give the following definitions of the transmit PSD for ISDN and HDSL:

$$PSD_{\text{ISDN}}(f) = K_{\text{I}} \frac{2}{f_0} \left(\frac{\sin(\pi f/f_0)}{\pi f/f_0} \right)^2 \frac{1}{1 + \left(\frac{f}{f_0}\right)^4} \quad (\text{C.1})$$

where $f_0 = 80$ kHz, $K_{\text{I}} = \frac{5}{9} \frac{V_p^2}{R}$, $V_p = 2.5\text{V}$, and $R = 135\Omega$. And for HDSL,

$$PSD_{\text{HDSL}}(f) = K_{\text{H}} \frac{2}{f_0} \left(\frac{\sin(\pi f/f_0)}{\pi f/f_0} \right)^2 \frac{1}{1 + \left(\frac{f}{f_{3\text{dB}}}\right)^8} \quad (\text{C.2})$$

where $f_0 = 392$ kHz, $f_{3\text{dB}} = 196$ kHz, $K_{\text{H}} = \frac{5}{9} \frac{V_p^2}{R}$, $V_p = 2.7\text{V}$, and $R = 135\Omega$.

Table C.1 shows the definition of a PSD-mask for ADSL on a line with POTS, as defined in [55]. The PSD is linearly interpolated from these values using a logarithmic frequency axis and a PSD axis linear in dBm/Hz. ADSL is a frequency divided and has different transmit PSD's in both the upstream and the downstream. This is in contrast to ISDN and HDSL that use the same PSD in both directions. Figure 4.4 shows the transmit PSD's for the these three systems. The VDSL specification from ETSI uses PSD-mask definitions expressed as in Table C.1 for ISDN and HDSL, and not the functional descriptions as defined in equations (C.1) and (C.2).

Through FEXT and NEXT couplings, alien crosstalk is created and becomes part of the background noise for VDSL. Depending on the number of disturbing systems and where VDSL is deployed (in the central office or in a cabinet) the background noise situation will look quite different. In [55] six different scenarios are defined: three central office or exchange based scenarios, and three cabinet based scenarios. These are referred to as background noise model A to F in the ETSI specification [15]. In Figure C.1 the background noise models A and D are shown (NEXT+FEXT but without AWGN). The noise levels are much lower for model A that represents a cabinet scenario, because the noise signals have been attenuated between the central office and the cabinet.

Table C.1: ADSL PSD-mask

Downstream		Upstream	
Frequency, kHz	PSD, dBm/Hz	Frequency, kHz	PSD, dBm/Hz
0	-97.5	0	-97.5
3.99	-97.5	3.99	-97.5
4.00	-92.5	4.00	-92.5
25.875	-39.5	25.875	-37.5
1104	-39.5	138	-37.5
3093	-90	307	-90
4545	-110	1221	-90
30000	-110	1630	-110
		30000	-110

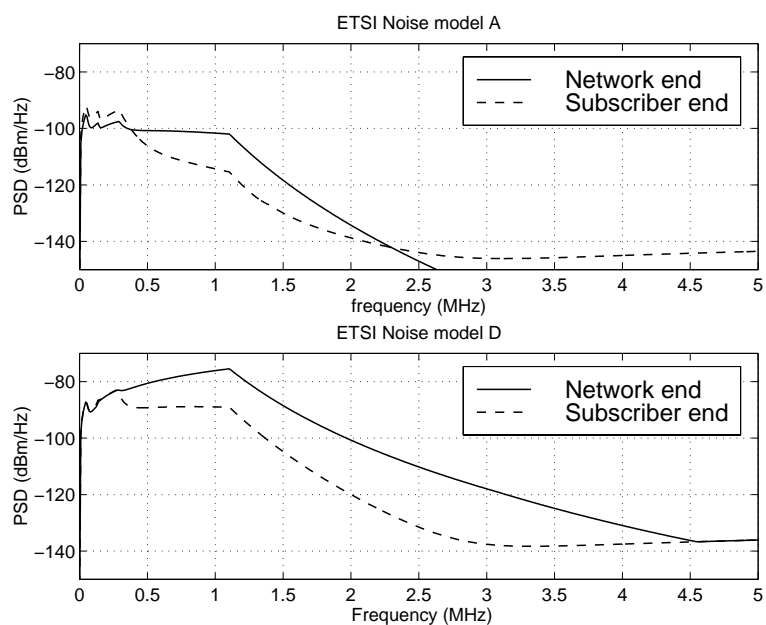

Figure C.1: ETSI background noise model A and D, for a 1000 meter DWUG cable.

Bibliography

- [1] T. Starr, J. M. Cioffi, and P. J. Silverman, *Understanding Digital Subscriber Line Technology*. Upper Saddle River, NJ: Prentice Hall, 1999.
- [2] “Integrated Services Digital Network (ISDN) — Basic Access Interface for Use on Metallic Loops for Application on the Network Side of the NT (Layer 1 Specifications),” Tech. Rep. ANSI Standard T1.601-1992, ANSI, New York, 1992.
- [3] “Transmission and Multiplexing (TM); High bit-rate Digital Subscriber Line (HDSL) transmission system on metallic local lines; HDSL core specification and applications for 2048 kbit/s based access digital sections,” Tech. Rep. ETR 152 ed.3, ETSI TM6, Dec. 1996.
- [4] J. Lechleider, “A Review of HDSL Progress,” *IEEE J. Select. Areas Commun.*, vol. 9, pp. 769–784, Aug. 1991.
- [5] J.-J. Werner, “The HDSL Environment,” *IEEE J. Select. Areas Commun.*, vol. SAC-9, pp. 785–800, Aug. 1991.
- [6] P. Chow, J. Tu, and J. Cioffi, “A discrete multitone transceiver for HDSL applications,” *IEEE J. Select. Areas Commun.*, vol. 9, pp. 895–908, Aug. 1991.
- [7] P. S. Chow, N. Al-Dhahir, and J. M. Cioffi, “A multicarrier E1-HDSL transceiver system with coded modulation,” *Eur. Trans. Telecommun. Rel. Technol.*, vol. 4, pp. 257–266, May 1993.
- [8] “For Telecommunications — Network and Customer Installation Interfaces — Asymmetrical Digital Subscriber Line (ADSL) Metallic Interface,” Tech. Rep. T1.413-1995, ANSI, 1995.
- [9] “Transmission and Multiplexing (TM); Assymmetric Digital Subscriber Line (ADSL); Requirements and performance,” Tech. Rep. DRAFT DTR/TM-03050, Version: 4 (960P07R0), ETSI-TM, Feb. 1996.
- [10] P. Chow, J. Tu, and J. Cioffi, “Performance evaluation of a multichannel transceiver system for ADSL and VHDSL services,” *IEEE J. Select. Areas Commun.*, vol. 9, pp. 909–919, Aug. 1991.
- [11] K. Sistanizadeh, P. Chow, and J. Cioffi, “Multitone Transmission for Asymmetric Digital Subscriber Lines (ADSL),” in *Proc. Intern. Conf. Commun.*, pp. 756–760, May 1993.
- [12] K. J. Kerpez and K. Sistanizadeh, “High Bit Rate Asymmetrical Digital Communications Over Telephone Loops,” *IEEE Trans. Commun.*, vol. 43, pp. 2038–2049, June 1995.
- [13] W. Y. Chen, “The development and standardization of asymmetrical digital subscriber line,” *IEEE Commun. Mag.*, vol. 37, pp. 68–72, May 1999.

- [14] “Very-high-speed Digital Subscriber Lines – System Requirements,” Tech. Rep. T1E1.4/98-043R8, ANSI, Plano, TX, Nov. 1998.
- [15] “Transmission and Multiplexing (TM); Access transmission systems on metallic cables; Very high speed Digital Subscriber Line (VDSL); Part1: Functional requirements,” Technical Specification TS 101 270–1 V1.1.6 (1999-08), ETSI, Aug. 1999.
- [16] J. M. Cioffi, V. Oksman, J.-J. Werner, T. Pollet, P. M. Spruyt, J. S. Chow, and K. S. Jacobsen, “Very-High-Speed Digital Subscriber Lines,” *IEEE Commun. Mag.*, vol. 37, pp. 72–79, Apr. 1999.
- [17] K. S. Jacobsen, “Synchronized DMT (SDMT) for very high-speed digital subscriber line (VDSL) transmission,” in *Proc. Globecom*, vol. 2, (Sydney, Australia), pp. 856–861, Nov. 1998.
- [18] A. Wang, J. J. Werner, and S. Kallel, “Effect of Bridged Taps on Channel Capacity at VDSL Frequencies,” in *Proc. Intern. Conf. Commun.*, (Vancouver, Canada), pp. 236–245, June 1999.
- [19] F. E. Gardiol, *Lossy transmission lines*. Boston: Artech House, 1987.
- [20] F. Olyslager, *Electromagnetic waveguides and transmission lines*. Oxford: Clarendon Press, 1st ed., 1999.
- [21] D. K. Cheng, *Field and Wave Electromagnetics*. Addison-Wesley, 2nd ed., 1989.
- [22] D. Johnson, J. Hilburn, J. Johnson, and P. Scott, *Basic Electrical Circuit Analysis*. Englewood Cliffs, N.J.: Prentice Hall, 5th ed., 1995.
- [23] I. Kalet, “The multitone channel,” *IEEE Trans. Commun.*, vol. 37, pp. 119–124, Feb. 1989.
- [24] I. Kalet and S. Shamai, “On the capacity of a twisted-wire pair: Gaussian model,” *IEEE Trans. Commun.*, vol. 38, pp. 379–383, Mar. 1990.
- [25] J. Cioffi, W. Yu, G. Ginis, S. Zeng, F. Sjöberg, and R. Nilsson, “Robust VDSL in the presence of Bridged Taps,” Tech. Rep. NT-039, ITU-SG15, Nashville, Tennessee, Nov. 1999.
- [26] L. Technologies, “Impact of Bridged Taps on VDSL Performance,” Tech. Rep. NT-091, ITU-SG15/Q4, Nashville, Tennessee, Nov. 1999.
- [27] J. Cook, R. H. Kirkby, M. G. Booth, K. T. Foster, D. E. Clarke, and G. Young, “The noise and crosstalk environment for ADSL and VDSL systems,” *IEEE Commun. Mag.*, vol. 37, pp. 73–78, May 1999.
- [28] J. Cook, “Wideband impulsive noise survey of the access network,” *BT Technol. Journ.*, vol. 11, pp. 155–162, July 1993.
- [29] W. Henkel and T. Kessler, “A wideband impulse noise survey in the German telephone network: statistical description and modeling,” *AEÜ*, vol. 48, pp. 277–288, Nov/Dec 1994.
- [30] R. Fano, “A theory of impulse noise in telephone networks,” *IEEE Trans. Commun.*, vol. 25, pp. 577–588, June 1977.

- [31] Bell Communications Research, “NYNEX loop performance survey: Report of results,” loop survey report, Bellcore, 1986.
- [32] R. Kirkby, “Statistics of Impulse Noise: Overview of BT WINS,” Tech. Rep. 993t18a0, ETSI STC TM6, Edinburgh, Scotland, Sept. 1999.
- [33] “Statistics of Impulse Noise: Interarrival Times,” Tech. Rep. 993t19a0, ETSI STC TM6, Edinburgh, Scotland, Sept. 1999.
- [34] S. Mclaughlin and D. B. Levey, “Statistics of Impulse Noise: Lengths and Energies,” Tech. Rep. 993t20a0, ETSI STC TM6, Edinburgh, Scotland, Sept. 1999.
- [35] R. Kirkby, “Statistics of Impulse Noise: Conclusions and Recommendations,” Tech. Rep. 993t21a0, ETSI STC TM6, Edinburgh, Scotland, Sept. 1999.
- [36] G. Komp, “Impulse noise measurements in the VDSL environment,” Tech. Rep. 972t15, ETSI TM6, Berlin, Germany, June 1997.
- [37] B. Mandelbrot, “Self-similar error clusters in communication systems and the concept of conditional stationarity,” *IEEE Transactions on Communications Technology*, pp. 71–90, 1965.
- [38] A. Ruiz, J. M. Cioffi, and S. Kasturia, “Discrete multiple tone modulation with coset coding for the spectrally shaped channel,” *IEEE Trans. Commun.*, vol. 40, pp. 1012–1029, June 1992.
- [39] M. Johnsson, “A study of impulse noise in telia’s loop plant,” master thesis 2000:039 CIV, Luleå University of Technology, Feb. 2000.
- [40] P. S. Chow, J. M. Cioffi, and J. A. C. Bingham, “A practical discrete multitone transceiver loading algorithm for data transmission over spectrally shaped channels,” *IEEE Trans. Commun.*, vol. 43, pp. 773–775, Feb/Mar/Apr 1995.
- [41] P. S. Chow, *Bandwidth optimized digital transmission techniques for spectrally shaped channels with impulse noise*. PhD thesis, Stanford University, CA, May 1993.
- [42] T. N. Zogakis, P. S. Chow, J. T. Aslanis, and J. M. Cioffi, “Impulse noise mitigation strategies for multicarrier modulation,” in *Proc. Intern. Conf. Commun.*, (Geneva), pp. 784–788, May 1993.
- [43] R. Nilsson, F. Sjöberg, S. K. Wilson, and P. O. Börjesson, “Combating Impulse Noise in DMT-based VDSL Systems,” in *Proc. Radioveten. Konf.*, vol. 1, (Karlskrona, Sweden), pp. 384–388, 1999.
- [44] M. Ghosh, “Analysis of the effect of impulse noise on multicarrier and single-carrier QAM systems,” *IEEE Trans. Commun.*, vol. 44, pp. 145–147, Feb. 1996.
- [45] B. R. Saltzberg, “Comparison of single-carrier and multitone digital modulation for ADSL applications,” *IEEE Commun. Mag.*, vol. 36, pp. 114–121, Nov. 1998.
- [46] G. Ungerboeck, “Performance of SCM and DMT in the presence of impulse noise,” Tech. Rep. FI-081, ITU-SG15, Fiji Islands, Jan/Feb 1999.
- [47] K. T. Foster, “The RFI environment for VDSL.” Distributed at IEEE Globecom ’96, VDSL Workshop, 18th November 1996, London.

- [48] R. Glenn, "EMC measurement results on various underground telephony plant," Tech. Rep. T1E1.4/98-038, ANSI, Austin, TX, Mar. 1998.
- [49] "Dr. Campbell's Memoranda of 1907 and 1912," *Bell System Tech. J.*, vol. XIV, pp. 552–572, Oct. 1935.
- [50] G. Foschini, "Crosstalk in outside plant cable systems," *Bell System Tech. J.*, vol. 50, pp. 2421–2448, Sept. 1971.
- [51] A. Gibbs and R. Addie, "The covariance of near end crosstalk and its application to pcm system engineering in multipair cables," *IEEE Trans. Commun.*, vol. COM-27, pp. 469–477, Feb. 1979.
- [52] E. A. Lee and D. G. Messerschmitt, *Digital Communication*. Norwell: Kluwer Academic Publishers, 2 ed., 1994.
- [53] W. Chen, J. Dixon, and D. Waring, "High bit rate digital subscriber line echo cancellation," *IEEE J. Select. Areas Commun.*, vol. 9, pp. 848–680, Aug. 1991.
- [54] FSAN VDSL working group, "A new analytical method for NEXT and FEXT noise calculation," Tech. Rep. T1E1.4/98-189, ANSI, Huntsville, AL, June 1998.
- [55] J. Cook, "Generator-based noise models for VDSL," Tech. Rep. 991t17a2, ETSI STC TM6, Villach, Austria, Feb. 1999.
- [56] "Technical Reference for High-Speed Digital Leased Circuit Services (transmission system on metallic subscriber lines)," tech. rep., Nippon Telephone and Telegraph: Advanced Telecommunications Services Sector, Tokyo, Japan, 1991.
- [57] J.-J. Werner, "Tutorial on carrierless AM/PM—Part I: Fundamentals and digital CAP transmitter." ANSI X3T9.5 TP/PMD contribution.
- [58] G. H. Im and J. J. Werner, "Bandwidth efficient digital transmission up to 155 Mb/s over unshielded twisted-pair cables," in *Proc. Intern. Conf. Commun.*, vol. 3, pp. 1797–1803, June 1993.
- [59] G. H. Im and J. J. Werner, "Bandwidth-efficient digital transmission over unshielded twisted-pair wiring," *IEEE J. Select. Areas Commun.*, vol. 13, pp. 1643–1655, Dec. 1995.
- [60] J. Proakis, *Digital communications*. Prentice-Hall, 3rd ed., 1995.
- [61] "Transmission and Multiplexing (TM); Access transmission systems on metallic cables; Very high speed Digital Subscriber Line (VDSL); Part2: Transceiver specification," Technical Specification TS 101 270-2 V0.1.0 (2000-03), ETSI, Mar. 2000.
- [62] J. Salz, "Optimum mean-square decision feedback equalization," *Bell System Tech. J.*, vol. 52, pp. 1341–1373, Oct. 1973.
- [63] M. Tomlinson, "New automatic equaliser employing modulo arithmetic," *Electron. Lett.*, vol. 7, pp. 138–139, 1971.
- [64] H. Harashima and M. Miyakawa, "Matched-transmission technique for channels with intersymbol interference," *IEEE Trans. Commun.*, vol. 20, pp. 774–780, 1972.
- [65] R. F. Fischer and J. B. Huber, "Comparison of precoding schemes for digital subscriber lines," *IEEE Trans. Commun.*, vol. 45, pp. 334–343, Mar. 1997.

- [66] R. W. Chang, "Synthesis of band-limited orthogonal signals for multichannel data transmission," *Bell System Tech. J.*, vol. 45, pp. 1775–1796, Dec. 1966.
- [67] B. R. Saltzberg, "Performance of an efficient parallel data transmission system," *IEEE Trans. Commun.*, vol. COM-15, pp. 805–811, Dec. 1967.
- [68] R. W. Chang and R. A. Gibby, "Theoretical study of performance of an orthogonal multiplexing data transmission scheme," *IEEE Trans. Commun.*, vol. COM-16, pp. 529–540, Aug. 1968.
- [69] S. B. Weinstein and P. M. Ebert, "Data transmission by frequency-division multiplexing using the discrete Fourier transform," *IEEE Trans. Commun.*, vol. COM-19, pp. 628–634, Oct. 1971.
- [70] J. A. C. Bingham, "Multicarrier Modulation for Data Transmission: An Idea Whose Time Has Come," *IEEE Commun. Mag.*, vol. 28, pp. 5–14, May 1990.
- [71] O. Edfors, M. Sandell, J.-J. van de Beek, D. Landström, and F. Sjöberg, "An introduction to orthogonal frequency-division multiplexing," Research Report TULEA 1996:16, Div. of Signal Processing, Luleå University of Technology, Sept. 1996.
- [72] "Radio broadcasting systems; Digital Audio Broadcasting (DAB) to mobile, portable and fixed receivers," ETS 300 401, ETSI – European Telecommunications Standards Institute, Valbonne, France, Feb. 1995.
- [73] "Digital broadcasting systems for television, sound and data services." European Telecommunications Standard, prETS 300 744 (Draft, version 0.0.3), Apr. 1996.
- [74] A. Peled and A. Ruiz, "Frequency Domain Data Transmission using Reduced Computational Complexity Algorithms," in *Proc. IEEE Int. Conf. Acoust., Speech, Signal Processing*, (Denver, CO), pp. 964–967, 1980.
- [75] O. Edfors, M. Sandell, J.-J. van de Beek, S. K. Wilson, and P. O. Börjesson, "OFDM channel estimation by singular value decomposition," *IEEE Trans. Commun.*, vol. 46, pp. 931–939, July 1998.
- [76] P. Moose, "A technique for orthogonal frequency-division multiplexing frequency offset correction," *IEEE Trans. Commun.*, vol. 42, pp. 2908–2914, Oct. 1994.
- [77] N. M. W. Al-Dhahir, *Optimized-transmitter reduced-complexity MMSE-DFE under finite-length constraints*. PhD thesis, Stanford University, California, June 1994.
- [78] N. Al-Dhahir and J. M. Cioffi, "Optimum Finite-Length Equalization for Multicarrier Transceivers," *IEEE Trans. Commun.*, vol. 44, pp. 56–64, Jan. 1996.
- [79] N. Al-Dhahir and J. M. Cioffi, "A Bandwidth-Optimized Reduced-Complexity Equalized Multicarrier Transceiver," *IEEE Trans. Commun.*, vol. 45, pp. 948–956, Aug. 1997.
- [80] P. J. Melsa, R. C. Younce, and C. E. Rohrs, "Impulse response shortening for discrete multitone transceivers," *IEEE Trans. Commun.*, vol. 44, pp. 1662–1672, Dec. 1996.
- [81] J. Tellado and J. M. Cioffi, "Revisiting DMT's PAR," Tech. Rep. T1E1.4/98-083, ANSI, Austin, TX, Mar. 1998.
- [82] X. Li and L. J. Cimini, "Effects of clipping and filtering on the performance of OFDM," *IEEE Commun. Lett.*, vol. 2, pp. 131–133, May 1998.

- [83] R. Gross and D. Veeneman, "Clipping distortion in DMT ADSL systems," *Electron. Lett.*, vol. 29, pp. 2080–2081, Nov. 1993.
- [84] D. Wulich and D. Goldfeld, "Reduction of peak factor in orthogonal multicarrier modulation by amplitude limiting coding," *IEEE Trans. Commun.*, vol. 47, pp. 18–21, Jan. 1999.
- [85] P. Frenger and A. Svensson, "Parallel combinatory OFDM signalling," *IEEE Trans. Commun.*, vol. 47, pp. 558–567, Apr. 1999.
- [86] J. Tellado and J. M. Cioffi, "Efficient algorithms for reducing PAR in multicarrier systems," in *Proc. IEEE Intern. Symp. Inf. Theory*, p. 191, Aug. 1998.
- [87] C. Gatherer and M. Polley, "Clip mitigation techniques for T1E1.413 issue3," Tech. Rep. T1E1.4/97-397, ANSI, Sacramento, CA, Dec. 1997.
- [88] J. M. Cioffi and C. Conroy, "DMT VDSL needs only a 12-bit ADC," Tech. Rep. T1E1.4/99-272R3, ANSI, Ottawa, Canada, June 1999.
- [89] C. Modlin and J. Chow, "Current and Projected Digital Complexity of DMT VDSL," Tech. Rep. T1E1.4/99-268, ANSI, Ottawa, Canada, June 1999.
- [90] C. Modlin and J. Chow, "Complexity comparison of DMT VDSL with QAM based VDSL," Tech. Rep. T1E1.4/99-269, ANSI, Ottawa, Canada, June 1999.
- [91] J. M. Cioffi, G. Dudevoir, M. Eyuboglu, and G. Forney, "MMSE DFE and Coding: Parts I/II," *IEEE Trans. Commun.*, vol. 43, pp. 2582–2604, Oct. 1995.
- [92] J. M. Cioffi and G. Forney, "Generalized DFE for Packet Transmission with ISI and Gaussian Noise," in *Selected Works in Honor of Thomas Kailath*, Boston: Kluwer, 1996.
- [93] L. Vandendorpe, L. Cuvelier, J. Louveaux, and B. Maison, "Asymptotic performance of MMSE MIMO decision feedback-equalization for uncoded single carrier and multi carrier modulations," in *Proc. Intern. Workshop on Copper Wire Access Systems (CWAS)*, (Budapest, Hungary), pp. 111–116, Oct. 1997.
- [94] S. D. Sandberg and M. A. Tzannes, "Overlapped Discrete Multitone Modulation for High Speed Copper Wire Communications," *IEEE J. Select. Areas Commun.*, vol. 13, pp. 1571–1585, Dec. 1995.
- [95] G. Cherubini, E. Eleftheriou, and S. Ölçer, "Filtered multitone modulation for VDSL," in *Proc. Globecom*, (Rio de Janeiro, Brazil), Dec. 1999.
- [96] M. Ho, J. M. Cioffi, and J. A. C. Bingham, "Discrete multitone echo cancelation," *IEEE Trans. Commun.*, vol. COM-44, pp. 817–825, July 1996.
- [97] D. C. Jones, "Frequency domain echo cancellation for discrete multitone asymmetric digital subscriber line transceivers," *IEEE Trans. Commun.*, vol. 43, pp. 1663–1672, Feb/Mar/Apr 1995.
- [98] J. M. Cioffi, J. S. Chow, J. A. C. Bingham, and P. Tong, "An SDMT line code proposal with rationale for support," Tech. Rep. T1E1.4/96-088, ANSI, Colorado Springs, CO, Apr. 1996.
- [99] "VDSL Alliance SDMT VDSL Draft Standard Proposal," Tech. Rep. T1E1.4/98-172, ANSI, Sacramento, CA, June 1998.

- [100] N. van Eijk, "Broadband service and local loop unbundling in the netherlands," *IEEE Commun. Mag.*, vol. 37, no. 10, pp. 106–109, 1999.
- [101] "VDSL Coallition Technical Draft Specification (Version 5)," Tech. Rep. 983t8, ETSI TM6, Luleå, Sweden, June 1998.
- [102] M. Isaksson, D. Bengtsson, P. Deutgen, M. Sandell, F. Sjöberg, P. Ödning, and H. Öhman, "Zipper – a duplex scheme for VDSL based on DMT," Tech. Rep. T1E1.4/97-016, ANSI, Austin, TX, Jan. 1997.
- [103] F. Sjöberg, M. Isaksson, P. Deutgen, R. Nilsson, P. Ödning, and P. O. Börjesson, "Performance evaluation of the zipper duplex method," in *Proc. Intern. Conf. Commun.*, (Atlanta, Georgia), pp. 1035–1039, June 1998.
- [104] F. Sjöberg, M. Isaksson, R. Nilsson, P. Ödning, S. K. Wilson, and P. O. Börjesson, "Zipper: A Duplex Method for VDSL Based on DMT," *IEEE Trans. Commun.*, vol. 47, pp. 1245–1252, Aug. 1999.
- [105] D. J. Mestdagh, M. R. Isaksson, and P. Ödning, "Zipper VDSL: A Solution for Robust Duplex Communication over Telephone Lines," *IEEE Commun. Mag.*, vol. 37, May 1999. to appear.
- [106] P. Ödning, M. Isaksson, D. Bengtsson, R. Nilsson, F. Sjöberg, and T. Stefansson, "VDSL Deployment, Services, and Customers – Part 1: Mixing of Symmetric and Asymmetric services on the bundle-level," Tech. Rep. 983t31, ETSI STC TM6, Luleå, Sweden, June 1998.
- [107] D. Bengtsson, P. Deutgen, N. Grip, M. Isaksson, L. Olsson, F. Sjöberg, and H. Öhman, "Zipper performance when mixing ADSL and VDSL in terms of reach and capacity," Tech. Rep. T1E1.4/97-138, ANSI, Clearwater Beach, Florida, May 1997.
- [108] D. Bengtsson, M. Isaksson, T. Stefansson, F. Sjöberg, and H. Öhman, "Co-existence between VDSL and ADSL (SP13)," Tech. Rep. 972t33r0, ETSI STC TM6, Berlin, Germany, June 1997.
- [109] F. Sjöberg, R. Nilsson, M. Isaksson, P. Ödning, and P. O. Börjesson, "Asynchronous Zipper," in *Proc. Intern. Conf. Commun.*, vol. 1, (Vancouver, Canada), pp. 231–235, June 1999.
- [110] M. Isaksson, F. Sjöberg, R. Nilsson, P. Ödning, D. Bengtsson, and D. Mestdagh, "Pulse Shaping with Zipper – Spectral Compatibility and Asynchrony," Tech. Rep. T1E1.4/98-041, ANSI, Austin, Texas, Mar. 1998.
- [111] P. Spruyt, P. Reusens, and S. Braet, "Performance of improved DMT transceiver for VDSL," Tech. Rep. T1E1.4/96-104, ANSI, Colorado Springs, CO, Apr. 1996.
- [112] F. Sjöberg, R. Nilsson, M. Isaksson, J. Cioffi, and S. K. Wilson, "Self-synchronizing a DMT-based VDSL system," in *Proc. Globecom*, (San Francisco, CA), Nov. 2000. Submitted to.
- [113] L. Olsson, M. Isaksson, D. Bengtsson, P. Deutgen, F. Sjöberg, G. Ökvist, P. Ödning, N. Grip, H. Öhman, and P. O. Börjesson, "Influence of the Zipper Duplex Scheme on the Receiver Dynamic Range," Tech. Rep. T1E1.4/97-139, ANSI, Clearwater Beach, Florida, May 1997.

- [114] J. Cioffi and Y. W. Ginis, George, “Vectored VDSL,” Tech. Rep. T1E1.4/99-449, ANSI, Clearwater, FL, Dec. 1999.
- [115] J. Cioffi, M. Isaksson, F. Sjöberg, R. Nilsson, W. Yu, G. Ginis, and S. Zeng, “Digital Duplexing: VDSL Performance Improved by Aversion of Frequency Guard Bands,” Tech. Rep. 993t13a0, ETSI STC TM6, Edinburgh, Scotland, Sept. 1999.
- [116] J. A. C. Bingham and M. Mallory, “RFI Egress Supression for SDMT,” Tech. Rep. T1E1.4/96-085, ANSI, Colorado Springs, CO, Apr. 1996.
- [117] J. A. C. Bingham, J. M. Cioffi, and M. Mallory, “SDMT Methods of Dealing with RFI,” Tech. Rep. 962t8, ETSI TM6, Stockholm, Sweden, June 1997.
- [118] L. de Clercq, M. Peeters, S. Schelstraete, and T. Pollet, “Mitigation of radio interference in xDSL transmission,” *IEEE Commun. Mag.*, vol. 38, pp. 168–173, Mar. 2000.
- [119] D. Fenton and T. Yeap, “A Digital Common-Mode Noise Canceller For Twisted-Pair Cable,” Tech. Rep. T1E1.4/99-260, ANSI, Ottawa, Canada, June 1999.
- [120] J. A. C. Bingham, J. M. Cioffi, and M. Mallory, “Digital RFI Cancellation with SDMT,” Tech. Rep. T1E1.4/96-083, ANSI, Colorado Springs, CO, Apr. 1996.
- [121] J. A. C. Bingham, “RFI supression in multicarrier transmission systems,” in *Proc. Globecom*, vol. 2, (London, UK), pp. 1026–1030, Nov. 1996.
- [122] B.-J. Jeong and K.-H. Yoo, “An Efficient Digital RFI Canceler for the DMT-based VDSL,” Tech. Rep. T1E1.4/97-422, ANSI, Sacramento, CA, Dec. 1997.
- [123] B. Wiese and J. A. C. Bingham, “Digital Radio Frequency Cancellation for DMT VDSL,” Tech. Rep. T1E1.4/97-460, ANSI, Sacramento, CA, Dec. 1997.
- [124] F. Sjöberg, R. Nilsson, N. Grip, P. O. Börjesson, S. K. Wilson, and P. Ödling, “Digital RFI Supression in DMT-based VDSL Systems,” in *Proc. Intern. Conf. on Telecomm. (ICT)*, vol. 2, (Chalkidiki, Greece), pp. 189–193, June 1998.
- [125] F. Sjöberg, R. Nilsson, P. O. Börjesson, P. Ödling, B. Wiese, and J. A. C. Bingham, “Digital RFI suppression in DMT-based VDSL systems,” *IEEE Trans. Commun.*, Jan. 1999. Submitted to.
- [126] A. J. Viterbi, *CDMA Principles of Spread Spectrum Communication*. Addison-Wesley, 1st ed., 1995.
- [127] F. Sjöberg, S. K. Wilson, and M. Isaksson, “Multi-rate power back-off in the upstream of VDSL,” *IEEE Trans. Commun.*, Nov. 1999. Submitted to.
- [128] FSAN VDSL working group, “Power back-off methods for VDSL,” Tech. Rep. 983t17, ETSI TM6, Luleå Sweden, June 1998.
- [129] T. Kessler, M. Friese, and M. Schlipp, “Achievable bitrates with the constant power back-off method,” Tech. Rep. 984t35, ETSI TM6, Vienna, Austria, Sept. 1998.
- [130] T. Pollet and P. Timmermans, “Power back-off strategies for VDSL – TDD versus FDD, performance comparison,” Tech. Rep. 985t24a0, ETSI STC TM6, Sophia Antipolis, France, Nov. 1998.

- [131] K. S. Jacobsen, "The Equalized FEXT Power Cutback Method to Mitigate the Near-Far FEXT Problem in VDSL," Tech. Rep. 985t05a0, ETSI TM6, Sophia Antipolis, France, Nov. 1998.
- [132] K. Jacobsen, "The impact of upstream power back-off on VDSL frequency planning," Tech. Rep. NG-048, ITU-SG15/Q4, Nuremberg, Germany, Aug. 1999.
- [133] M. Isaksson, T. Stefansson, P. Ödling, F. Sjöberg, and S. K. Wilson, "Option for inband POTS and ISDN," Tech. Rep. T1E1.4/97-282, ANSI, Minneapolis, Minnesota, Sept. 1997.
- [134] J. Cook and P. Sheppard, "ADSL and VDSL splitter design and telephony performance," *IEEE J. Select. Areas Commun.*, vol. 13, pp. 1634–1642, Dec. 1995.
- [135] D. Bengtsson, M. Isaksson, T. Stefansson, F. Sjöberg, and H. Öhman, "Co-existence between VDSL and ADSL," Tech. Rep. T1E1.4/97-286, ANSI, Minneapolis, Minnesota, Sept. 1997.
- [136] K. S. Jacobsen, "Spectral compatibility of ADSL and VDSL, part1: The impact of VDSL on ADSL performance," Tech. Rep. T1E1.4/97-404R1, ANSI, Sacramento, CA, Dec. 1997.
- [137] K. S. Jacobsen, "Spectral compatibility of ADSL and VDSL, part2: The impact of ADSL on VDSL performance," Tech. Rep. T1E1.4/98-035, ANSI, Austin, TX, Mar. 1998.
- [138] K. S. Jacobsen, "Interactions between ADSL and VDSL in the same binder: Simulations and test results," Tech. Rep. T1E1.4/99-298, ANSI, Ottawa, Canada, June 1999.
- [139] Y. Okamura (NEC), "Draft Liaison to HomePNA (Home Phoneline Networking Alliance)," Tech. Rep. T1E1.4/99-098, ANSI, Jan. 1999.
- [140] J. Cioffi and et al., "Soft Cancellation via Iterative Decoding to Mitigate the effect of Home-LANs on VDSL," Tech. Rep. T1E1.4/99-331, ANSI, Baltimore, MD, Aug. 1999.
- [141] K. Cheong and J. M. Cioffi, "Coexistence of 1 Mbps HPNA and DMT VDSL via Multiuser Detection and Code Division Multiplexing," Tech. Rep. T1E1.4/99-120, ANSI, Jan. 1999.