

Mystery of Mosul Dam the most Dangerous Dam in the World: The project

**Nadhir Al-Ansari¹, Issa E. Issa², Varoujan Sissakian³, Nasrat Adamo⁴, Sven
Knutsson⁵**

Abstract

Mosul Dam is an earthfill multipurpose dam. It is located on the River Tigris in northwestern Iraq. The dam is 3.65 km long and its crest elevation is at 341 m above sea level. The storage capacity at normal operation level (330 m above sea level) is 11.11km³. The work to build the dam started on 25thJanuary, 1981 and finished on 24thJuly, 1986. The total cost of the development was estimated at 2.6 billion US\$. The foundation of the dam lies on the Fatha Formation. This formation is composed of alternating beds of marls, limestone, gypsum and claystone. It is highly karstified, which has which created a lot of problems during the construction, impounding and operation phases.

Keywords: Mosul Dam, Karstification, Gypsum, Iraq, Geology of Mosul Dam.

1 Introduction

The rivers Tigris and Euphrates form the main water resources of Iraq. Most of the water from these rivers comes from Turkey (71%) followed by Iran (6.9%) and Syria (4%). The remainder, only 8%, is from internal sources [1,2,3]. The average annual flow of the rivers Euphrates and Tigris is estimated to be about 30 km³ (which might fluctuate from 10 to 40 km³) for the former and 21.2 km³ for the latter when they enter Iraq. The Tigris River tributaries in Iraq contribute 24.78 km³ of water and there is about 7 km³ of water brought by small wadies from Iran, which drain directly towards the marsh area. The Euphrates River doesn't have tributaries inside Iraq. Groundwater resources are estimated about 1.2 x 10⁹ m³ and form about 2% of the total water resources of Iraq [4].

^{1,2,5}Dept. of Civil, Environmental and Natural Resources Eng., Luleå University of Technology.

³ Consultant geologist, Erbil, Iraq.

⁴ Consultant Engineer, Sweden.

Iraq started controlling its water resources since 1939 when the first barrage was constructed at Kut on the Tigris River. The idea of building dams in Iraq started in the first half of the twentieth century. Primarily it was to protect Baghdad the capital and other major cities from flooding (Fig. 1). The first big dam (Dokan) was constructed on the Lesser Zab River. They started its construction in 1956. Later, dams and regulators were constructed for irrigation and power generation purposes (Iraqi General Commission for Dams and Reservoirs, 2006; Iraqi Parliament, 2009). The natural depressions are included within the hydrological scheme as flooding escapes such as Al-Therthar depression.

The Iraqi Government realized the process of building dams should be speeded up due the huge increase of water demand and the threat of halting water of the rivers by Turkey and Syria. The process was stopped in the 1990's due to the second Gulf War and UN sanctions. None of these dams was filled to its maximum storage capacity during the twenty first century. This is attributed to the depletion of flow in the Euphrates and Tigris Rivers due to the Turkish and Syrian dams. It is noteworthy to mention that Haditha Dam is almost of no use now due to the severe depletion of the Euphrates flow[2,3,5,6].

The idea of building of Mosul Dam project started in 1950 and it was referred to as AskiMosul Dam [1]. The location of the dam was suggested by two British companies AlxeanderGhbbs and partners and MunsellBassford andBafery in 1953 to be at a village called "Dhaw Al-kamar", which is located 12km north of AskiMosul. The dam was designed so that its capacity reaches 8.7km^3 at 320 m ((a.s.l.)) while the maximum elevation of the dam reaches 324 m ((a.s.l.)).

Later in 1956, the Iraqi Development Council asked an American company (Koljian) to carry out a new site investigation for the dam to use it for irrigation purposes. This company handed its report in 1957 suggesting that the dam should irrigate about one million donums (1 donum= 0.25 hectare) distributed at North, South and East Al-jazera. In the same year, the Iraqi Government asked Harza Company to perform a new site survey and design for the dam. In 1960, Harza Company suggested two sites for the dam; different from those suggested earlier by other companies. This is attributed to the fact that, earlier locations are not suitable because the dam will be built on highly soluble gypsum and very thin clay beds. The first suggested site was to build a dam with a storage capacity of 7.8 km^3 at 320 m ((a.s.l.)) and the other site was at 335 m ((a.s.l.)) with a storage capacity of 13.5 km^3 . In 1962, the Iraqi Government asked Technoprom Export (Soviet company) to perform another investigation for the site of Mosul Dam and to suggest a new design as well. The company suggested a new site that is 600 m south of the site suggested by Harza Company. The dam was designed with a storage capacity of 7.7km^3 at 312.4 m ((a.s.l.)) and the maximum height of the dam was supposed to be 83.7m.

All the above companies suggested that the dam should be of rock-fill type with compressed clay core but there were different views about the exact location of the dam, spillway and electricity generation station. Grouting was suggested to be performed under the dam, spillway and the electricity generation station. In addition, they suggested that detailed geological investigation should be performed before any construction activities. In view of these reports, the Iraqi Government asked a Finish company "AmitranVoima" in 1965 to carry out new investigations. The dam at that time was supposed to irrigate 3 million donums at Mosul, Baghdad, Kut, Nasiriyah, Amarah and Basra Governorates. The company suggested a site, which is located 60km northwest of Mosul city. It was pointed out the geology of the area is so complex and requires further investigations. Another

Yugoslav company (Geotcnica) worked on the geology of the suggested site in 1972 according to the advice of the International Board of Dams (IBD) and the report submitted by the Russian TechnopromExport Company. AmitranVoima Company carried out another investigation in 1973. According to these reports, IBD recommended in 1974 extra geological investigations.

The Iraqi Directorate General for Dams asked a French company (Soletanch previously known Soleseif) to perform more geological investigation on the suggested site. This was done during 1974-1978. Later in 1978, the Swiss Consultants Consortium was asked to be the consultants for Mosul Dam project. The consultants suggested that the operational water level at the dam to be 330 m((a.s.l.)) while the flood and normal water levels to be 338 and 335 m((a.s.l.)) respectively. A consortium of German and Italian companies (GIMOD) was asked to execute the civil and steel work of the project in 1980. While electromechanical plant of the power station was given to the Japanese company (Toshiba) on the condition that the capacity of the plant will be 750 MW. The electromechanical plant contract for the regulation dam was awarded to (Elin Union) from Austria, while the electromechanical plant for the pump storage scheme was given to (G.I.E) from Italy. The work started on 25th January, 1981 and finished 24th July, 1986. The total cost of the development was estimated at 2.6 billion US\$ at the prices level of 1985.

In this research, the project area will be discussed and problems encountered will be highlighted.

2 Climatic Features

The climate of the catchment area can be regarded as being similar to a Mediterranean climate, except some differences due to the presence of a mountainous region, which is located within the Turkish territory. The climate is a hot-dry summer and cold-rainy winter with occasional snowing in the mountains region. The precipitation in the Tigris River basin occurs between October and May. The annual precipitation over the Tigris basin ranges between 450 -1000 mm annually [2,3,6] while it is 200-600 mm at the dam site [7]. The heaviest precipitation occurs from December to February. Generally, snow melting begins in February. Therefore, the flood runoff continues to May or early June. After this the flow rates are reduced where the lower rates occur in August to October. During this period the main source of the river runoff is the groundwater. The average monthly temperatures range between 6°C in January to 34°C in July but the temperatures decrease towards the north [7].

3 River Tigris and Catchment Area of Mosul Dam

The Tigris River is one of the two most significant rivers in western Asia and main source of water for Mosul Dam reservoir. The main source for the Tigris River is Hazar Lake, which is located in the south eastern region of Turkey. The lake is surrounded by the Taurus Mountain chain where the elevation reaches 3500 m. The catchment area of the River Tigris is divided geographically into three regions: mountainous, foot hills and the plain region. Its estimated that the catchment area upstream of Mosul Dam reservoir is

about 54900 km², which is shared by Turkey, Syria and Iraq [8,9] and the catchment area of the valleys surrounding the reservoir is about 1375 km² [10]. The Tigris River flows in hilly regions located to the south western part of the mountainous area connecting Turkey, Iran and Iraq. The River crosses the Iraqi border in FaishKhabur village, which is located about 400 km from the main source and 128 km upstream of Mosul Dam. Four major tributaries, Batman, Garzan, Botan and Al-Khabur feed the Tigris River north of Mosul Dam from the left bank [6,11]. Six large dams in Turkish territory had been constructed on the River Tigris upstream of Mosul Dam during the last century [12]. The channel of the Tigris River is shallow and wide in the Diyarbakir area, but after it merges with the Batman tributary it becomes a narrow and deep river with high velocity.

The width of the river valley (flood plain) north of Mosul city to FaishKhabur; before Mosul Dam construction ranged from 2 to 10 km and the average water surface slope in this reach was 0.65 m.km⁻¹ [8,11]. The banks of the river valley have steep slopes from the right hand side and gentle low slopes from the left hand side. The most significant features of the River Tigris basin are given in (Table 1).

The annual hydrograph for the Tigris River starts from October to September. The highest mean monthly discharge takes place during April and the driest month is generally September (Fig. 2).

The average monthly discharge for the River Tigris is 631 m³.sec⁻¹ for years 1931 to 2013 and the maximum discharge was 3514 m³.s⁻¹ in April 1954 while, the minimum was 81 m³.sec⁻¹ in October 2013 (Fig. 3). The sediment on the bed of the river before construction of the dam had a median grain size diameter of d₅₀=18 mm [8,11]. In 2009, the sediments of the river were studied by the Dijla Company for Engineering Design and they noted that the specific gravity for bed material was G_s=2.65 while the median grain size diameter of the sediment was d₅₀= 12.4mm [7].

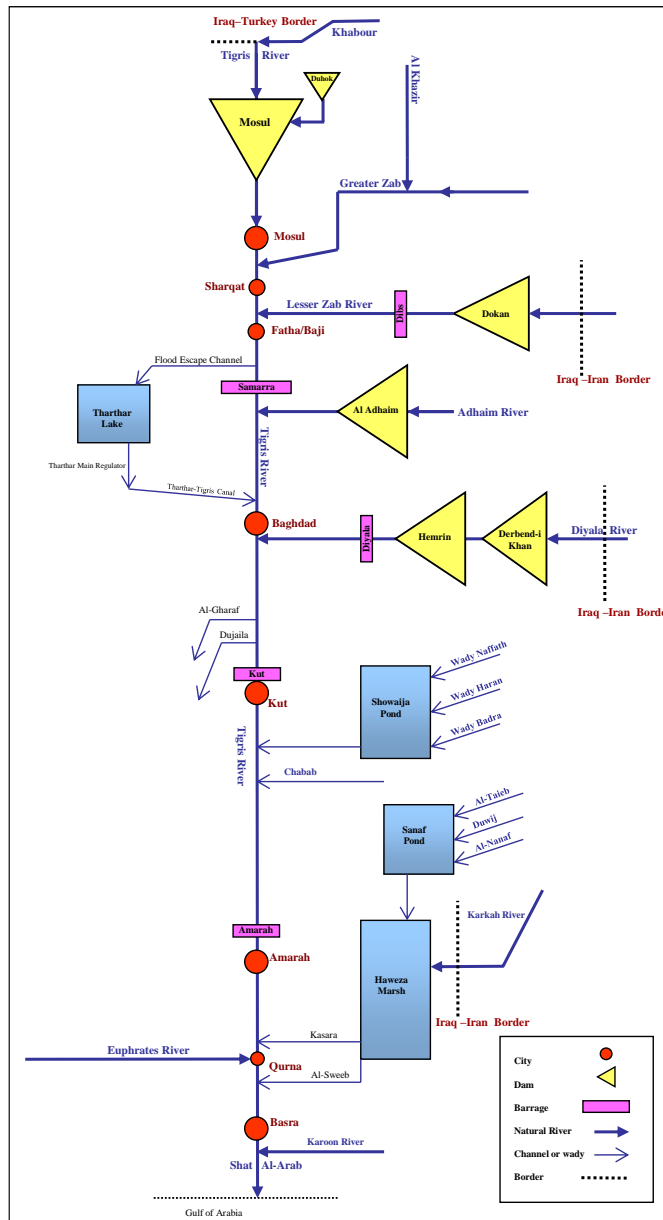

Figure 1: Schematic diagram of Tigris River and its tributaries hydrological scheme [13].

Table 1.Characteristics of the Tigris River’s basin.

Tigris River	Turkey	Iraq	Syria	Iran	Total
Discharge (km ³ year ⁻¹)	33.5	6.8	negligible	11.2	51.5
Discharge (%)	65.0	13.2	negligible	21.8	100
Drainage Area (km ²)	45 000	292 000	1 000	37 000	375 000
Drainage Area (%)	12.0	54.0	0.2	33.80	100
River Length (km)	400	1318	44	–	1862
River Length (%)	21.0	77.0	2.0	–	100

Source:[12].

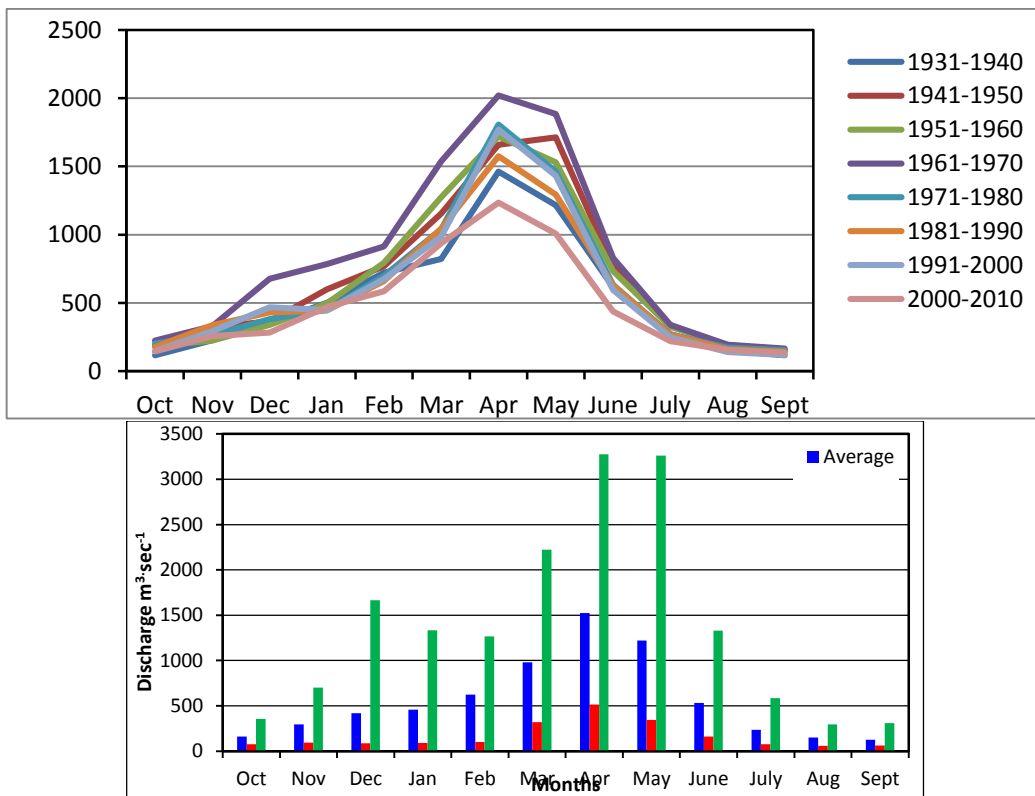

Figure 2: Monthly (mean, minimum and maximum) inflows of Tigris River at dam site (1931-2013).

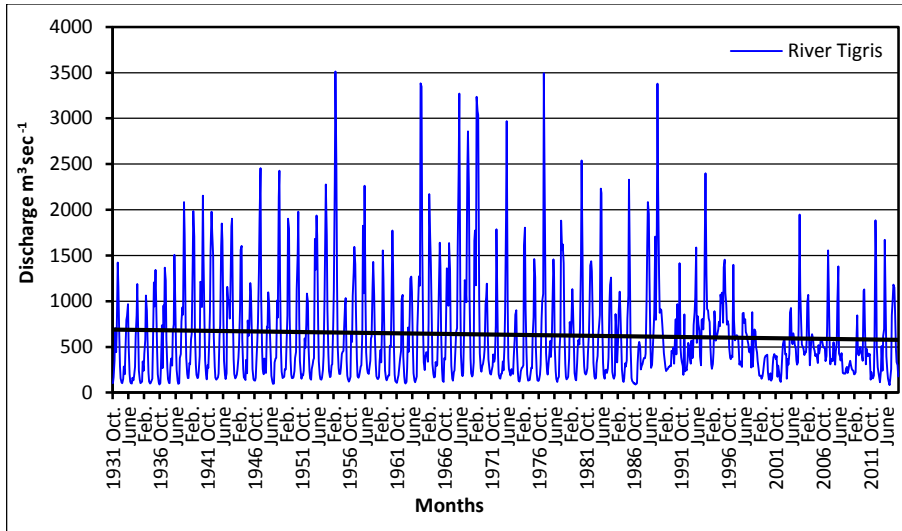

Figure 3: Average monthly inflow and its trend line of the Tigris River at dam site (1931-2013).

4 Mosul Dam

Mosul Dam is one of the most important strategic projects in Iraq for the management of its water resources. The project was constructed on the Tigris River in the northwest of Iraq, located 60 km northwest of Mosul city and 80 km from the Syrian and Turkish borders at 4056066 N northing and 305356.69 E easting [14](Fig. 4).

Construction of Mosul Dam began on January 25th, 1981. The dam is a multipurpose project and it started operating on 24th July, 1986, to provide water for three irrigation projects at the north of Iraq and other projects in the middle and south of the country, flood control and hydropower generation. The dam is 113 m high, 3650 m long including the spillway, has a 10 m top width and the crest level is 341m (a.s.l.) The dam is faced with rock and has an earth fill with a clay core [14]. The maximum, normal and dead storage levels of the reservoir are 335, 330 and 300 m ((a.s.l.)) respectively. The dam was designed to impound 11.11 km³ of water at normal operation level, including 8.16 and 2.95 km³ of live storage and dead storage, respectively (Fig. 4&5).

The dam has a concrete spillway located on the left abutment of the main dam (Fig. 4). The crest elevation of the spillway is 330 m (a.s.l.) and its length is 680 m. The spillway has five radial gates; measuring 13.5 m×13.5 m giving a discharge of 12600 m³.sec⁻¹ at the maximum reservoir level of 338 m (a.s.l.) [14].

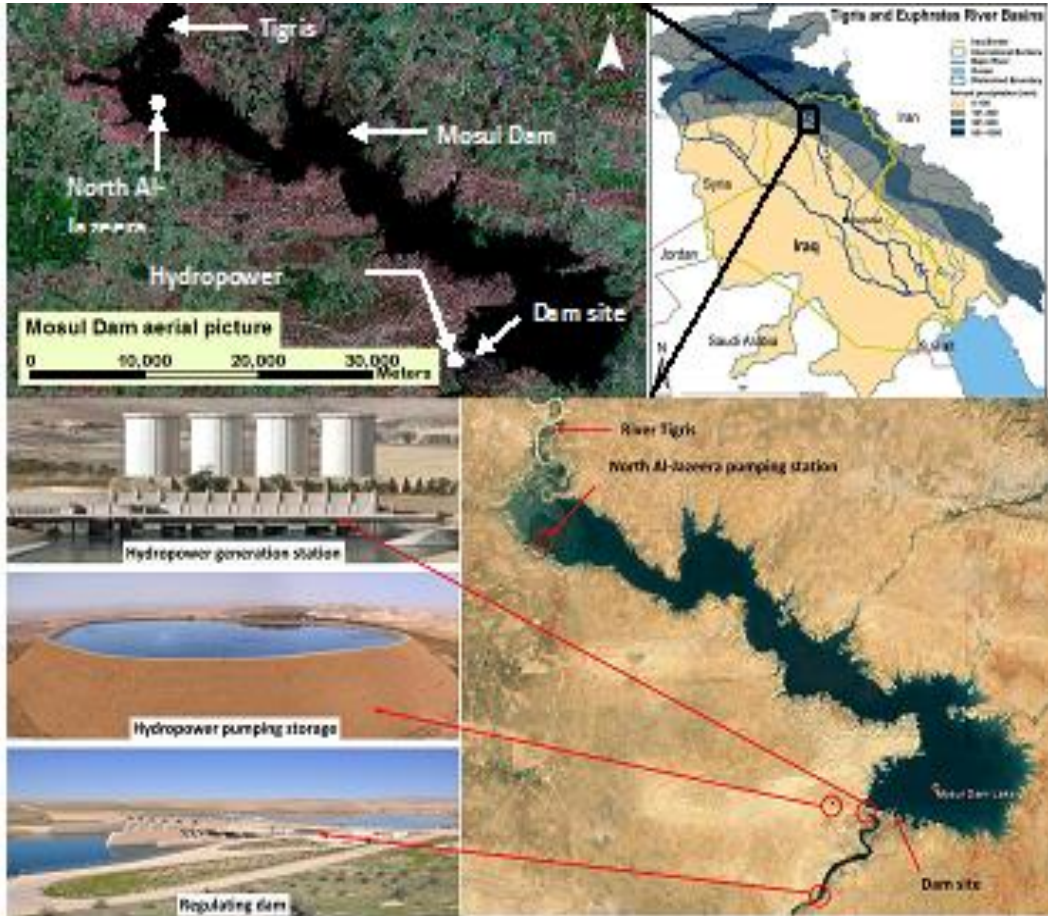

Figure 4: Location of Mosul Dam with main facilities.

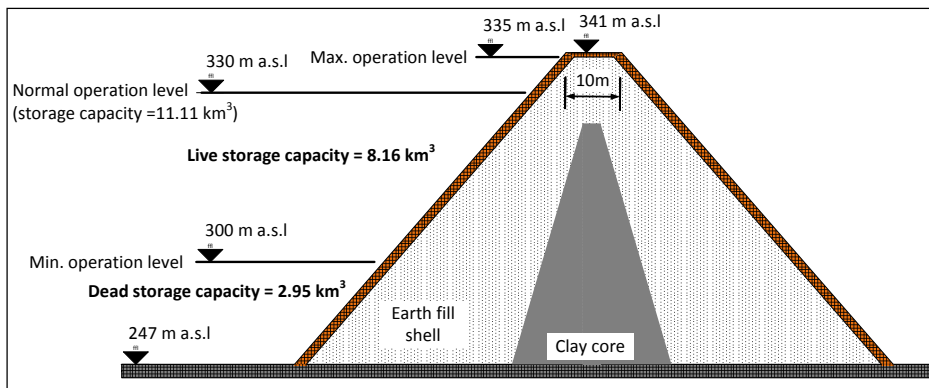

Figure 5: Schematic diagram of Mosul Dam cross section.

The power generation and pumping station of the north Al-Jazeera project are the important structures within the dam project, which were relied upon to monitor the water level during the bathymetric survey. The power generation facilities are located on and in the right abutment of the main dam (Fig. 4). The power house is located in the toe of the dam embankment and includes four turbines with total generation capacity of 750 MW.

The Al-Jazeera pumping station is located in the upper zone of the reservoir, 278409 E and 407663 N with a maximum water discharge $45 \text{ m}^3 \cdot \text{sec}^{-1}$ (Fig. 4) [14].

5 Mosul Dam Reservoir (MDR)

The reservoir is located between latitude (4055000 to 4086000) N and longitude (275000 to 320000) E. The shape of the reservoir is almost elongated where the River Tigris enters the upper zone and expands close to the dam site. The length of the reservoir is about 45 km and its width ranges from 2 to 14 km with water surface area about 380 km^2 at the maximum operation level of 330 m (a.s.l.). There are seven main valleys that feed the reservoir from the left side and three from the right side of the reservoir [10]. The characteristics of these valleys are shown in (Table 2). The sediment of these valleys is mostly silty loam, silty clay, loam and clay. The annual sediment delivered by the right and left sides valleys of MDR were 42.7×10^3 ton and 702×10^3 ton, respectively [10,15].

Table 2: Properties of the main tributary valleys around Mosul reservoir.

Valleyname	Sidefeeding	Area (km^2)	Slope (%)	Length km	Mean basin level (ma.s.l.)
Sweedy	Right	450.76	0.0359	38.8	446.62
Kara Kandy	Right	78.52	0.0217	21.82	388.38
KhuyrHara	Right	50.06	0.0525	10.86	404.89
Amlik	Left	88.95	0.0281	38.94	470.42
Jardyam	Left	88.73	0.0215	52.68	457.1
Affkery	Left	139.5	0.0214	58.04	445.34
KhrabMalk	Left	119.6	0.0255	51.32	475.87
Naqeb	Left	104.1	0.0143	54.71	426.52
Kalaq	Left	162.26	0.0173	60.52	424
SaeedThaher	Left	92.25	0.026	43.23	414

Using the data available from the Iraqi Ministry of Water Resources the average monthly inflow and outflow of the reservoir were 561 and $555 \text{ m}^3 \cdot \text{sec}^{-1}$ for the period 1986 to 2011 of its operation (Fig. 6). Mosul Dam operates to provide storage for three irrigation projects, power generation, regulation and flood control for the Tigris River and recreation. Dam operation started during June, 1984 with initial reservoir filling during the spring of 1985, but the actual operation began in July, 1986 [1]. The operation mode of the dam during 1986-2011 is shown in figures (6) and (7) for discharges and water elevations, respectively.

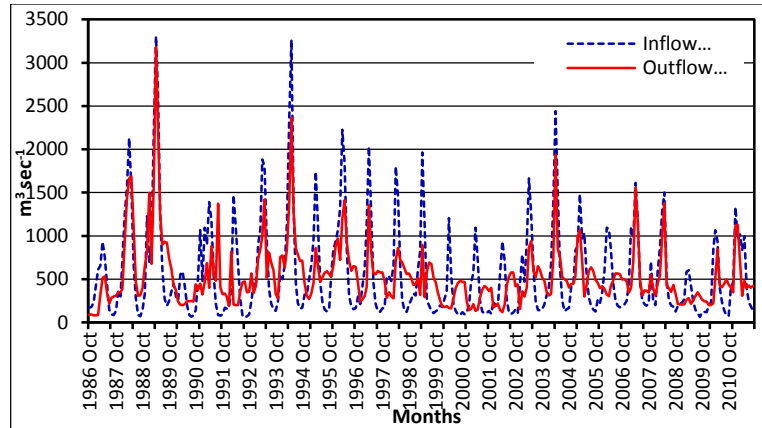

Figure 6: Average monthly inflow and outflow discharges of MDR for 1986-2011.

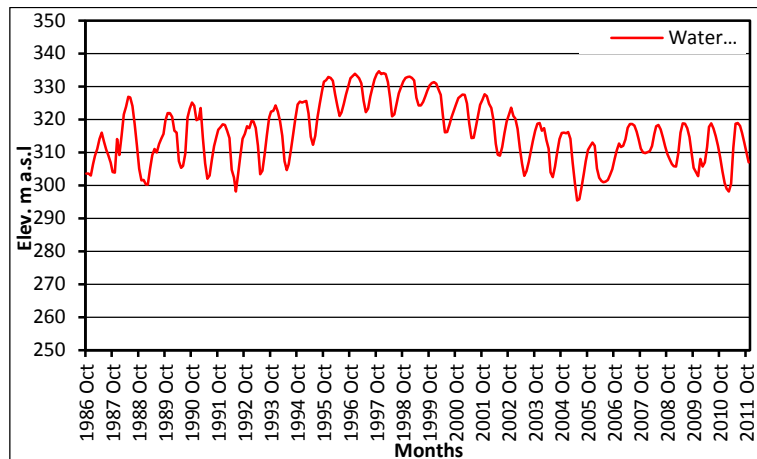

Figure 7: Average monthly water elevations of MDR for 1986-2011.

6 Geology of the Dam Site

The dam abutments are located on the Upper Member of the Fatha Formation (Middle Miocene) (Fig. 8). The Upper Member, as the Lower Member of the Fatha Formation consists of cyclic sediments, marls, claystone, limestone and gypsum; however, in the uppermost part the claystone ratio increases as compared with the lower part. These inhomogeneous rocks; in their mechanical behavior will certainly behave differently when are loaded. The gypsum and limestone beds are usually karstified, but the karstification is less in the Upper Member as compared to Lower Member of the Fatha Formation [16,17]. This is attributed to the presence of more clastics in the Upper Member than those of the Lower Member of the Fatha Formation, besides that gypsum and limestone beds become thin in the uppermost parts of the formation. Figure 9 shows the detailed description of the beds at Mosul Dam site.

Due to the complexity of the geology of the area, several investigations were carried out (e.g. [18, 19, 20]. Al-Ansari et al., [18] reported that there were two faults within the dam site area. The fault is of rotational type striking NW-SE offsetting the northern corner of

Butmah East structure. The throw of the fault increases towards the east. The fault plane is believed to be nearly vertical; near the surface with a slight dip towards the north. They also reported that this fault extends to the dam site. The other fault is trending N NE-S SW along the right bank of the River Tigris. This fault is not clear on the surface and it was detected using landsat images. This is due to the fact that the fault is deep seated and it might be partly controlling the Tigris River course from the dam site to Aski Mosul. Wakeley et.al [20] collected all the borehole data and constructed a model to show the complex geology at the dam site (see figures 10&11).

No neotectonic activity is reported from the dam site and near surroundings [21], as well the present small faults, as discovered in the dam site during execution of detailed geological mapping by Iraq Geological Survey (Hagopian, 1984, personal communication) has no significant importance and/ or cause any hazard for the dam. Even the main deep seated Sassan – Be'Khair Fault [22], shows no surface indication for any recent activity, as recognized by Saleh [23]. Therefore, the surface area of the dam site almost doesn't suffer from active tectonic disturbances; this is also confirmed by [24], when they stated that the dam body does not suffer from any problem.

The most significant geological hazard that influences Mosul Dam is the karstification, especially in the foundation's rocks. According to [25] the karstification had scored 5.5 degrees within the existing geological hazards; not only in the dam site but, in the whole Mosul Quadrangle at scale of 1:250 000 that covers an area of about 30000 Km². The influence of the karstification is also confirmed by [8,17,18,25,26,27,28,29, 30]. Another geological hazard in Mosul Dam and reservoir is the slope stability. The slope stability of dams is discussed and confirmed by many authors, among them are: [31,32,33,34,35]. The landslides occur either due to quick draw down or oversaturation of the rocks, especially when claystone or marl occur in the rock sequence surrounding the reservoir. In Mosul, the lithology of the Fatha Formation is very favorable for development of landslides, especially when the beds are dipping towards the reservoir, which is the case in Butma East, AinZala, Musoura, Dahqan and Qand anticlines. However, the existing landslides in the reservoir area are not so large; therefore, they did not impose significant hazard on the dam body.

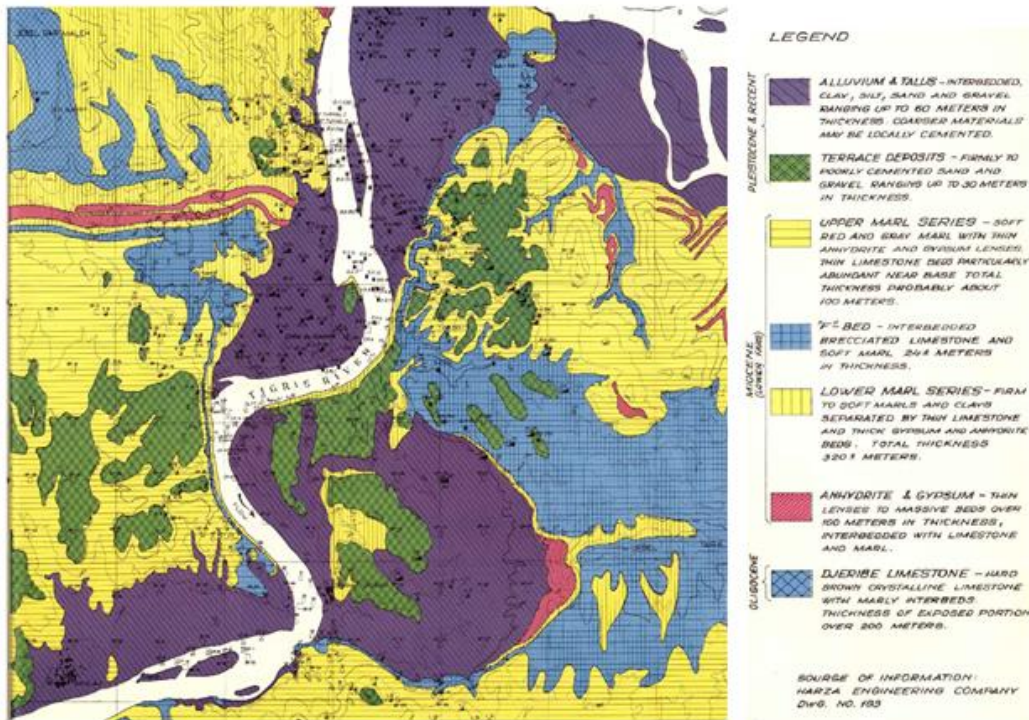

Figure 8: Geologic map of Mosul Dam site area [36].

7 Conclusions

Mosul Dam is located on the Tigris River in northwestern Iraq; approximately 60 km northwest of Mosul city and 80 Km from Syria and Turkey. It is a multipurpose project for irrigation, flood control and hydropower generation. It is 113 m in height, 3.4 km in length, 10 m wide in its crest and has a storage capacity of 11.11 billion cubic meters. The water surface area of the reservoir at the beginning of the dam operation was 380 km² with a storage capacity of 11.11×10⁹ m³ at the maximum operation level 330 m.a.s.l including 8.16×10⁹ m³ live storage and 2.95×10⁹ m³ dead storage. It is an earth fill dam, constructed on bedrocks of the Fatha Formation, which consists of gypsum beds alternated with marl and limestone, in cyclic nature. The thickness of the gypsum beds attains 18 m; they are intensely karstified even in foundation rocks. This has created number of problems during construction, impounding and operation of the dam.

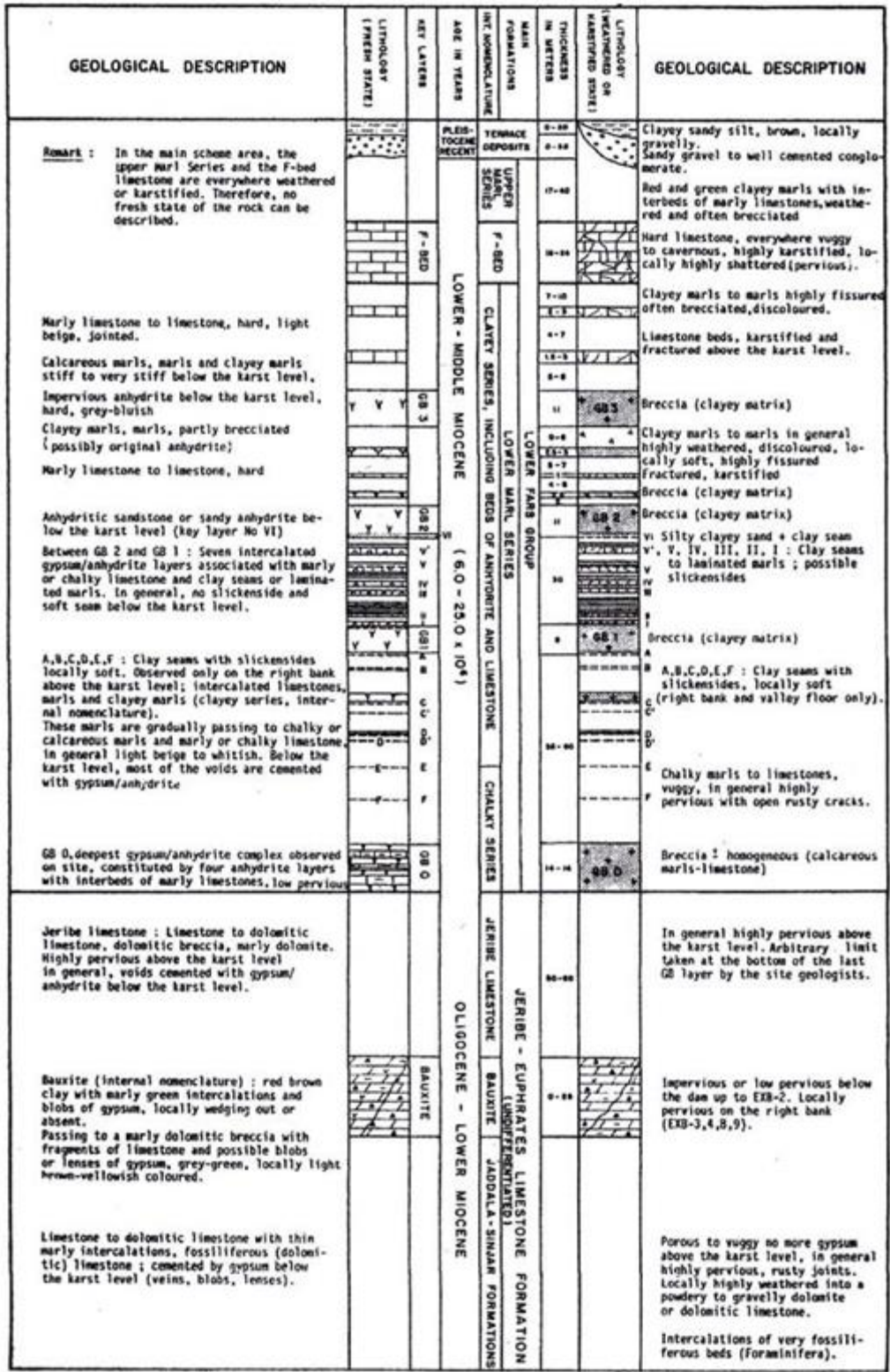

Figure 9: Lithological column of beds at Mosul Dam site [19].

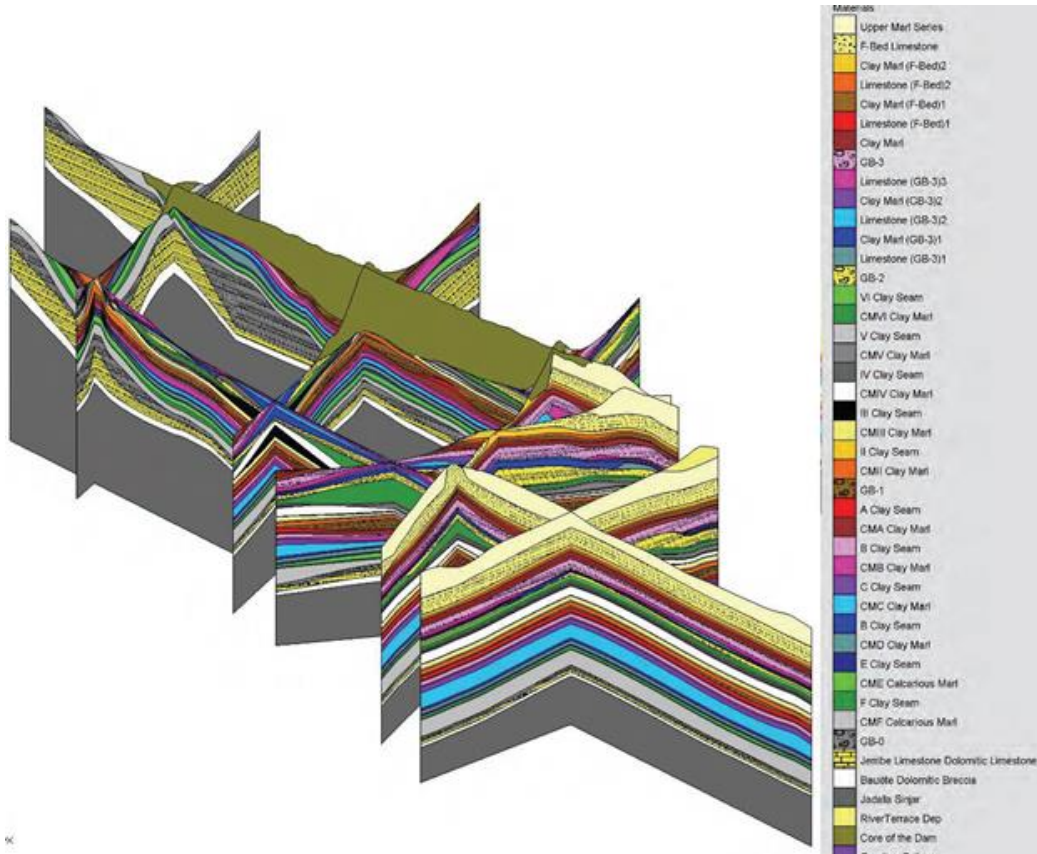

Figure 10: Intersecting cross sections from intermediate version of ERDC geologic conceptual model, showing complex stratigraphy and partial resolution of discrepancies in stratigraphy at intersections of the geologic panels from generated boreholes [24].

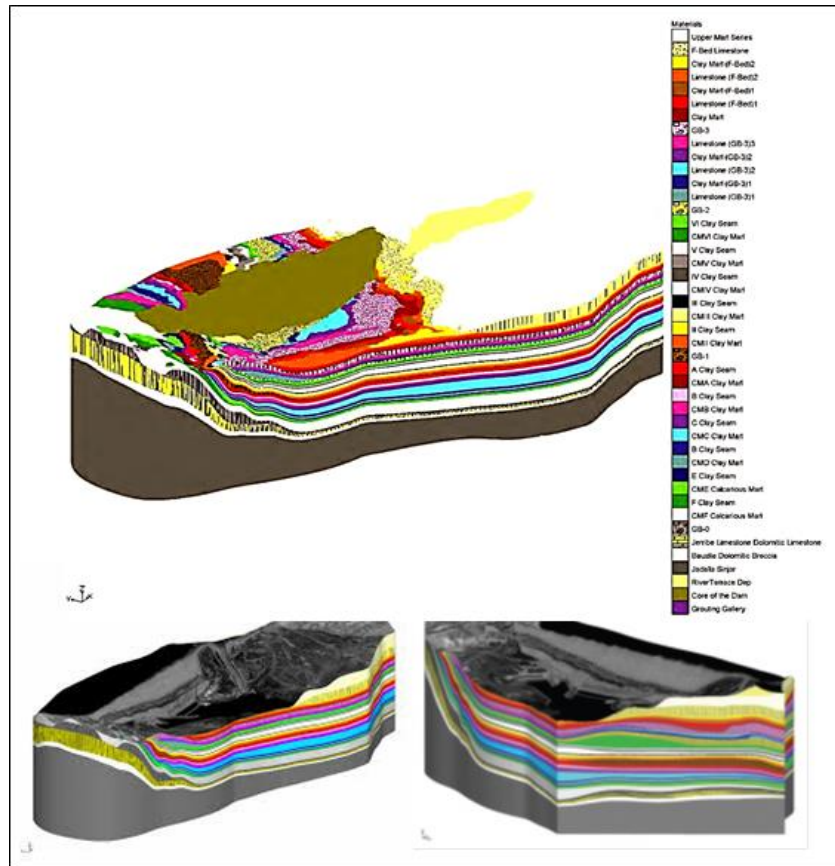

Figure 11: Three dimensional model of Mosul Dam site [24].

ACKNOWLEDGEMENTS: The authors would like to thank all individuals for their help and assistance in this work. Special thanks are to Mr. Mohammed Dhari, the Construction Advisor of the Iraqi Ministry of Water Resources for his kind assistance, encouragement and support.

The research presented has been financially supported by Luleå University of Technology, Sweden and by “Swedish Hydropower Centre—SVC” established by the Swedish Energy Agency, Elforsk and SvenskaKraftnät together with Luleå University of Technology, The Royal Institute of Technology, Chalmers University of Technology and Uppsala University. Their support is highly appreciated.

References

- [1] Iraqi Ministry of Water Resources-Iraq, the strategic study for Iraqi water resources and lands, 2014, in Arabic, <http://www.mowr.gov.iq/?q=node/902>, last access: 26-June-2014.
- [2] Al-Ansari, N.A., Ali, A. and Knutsson, S., Present conditions and Future Challenges of Water Resources Problems in Iraq, J. Water Resources and Protection, 6, 12,1066-1098, 2014.

- [3] Al-Ansari, N.A., Ali, A.A. and Knutsson, S., Iraq Water Resources Planning: Perspectives and Prognoses, ICCCE 2015 : XIII International Conference on Civil and Construction Engineering, Jeddah, Saudi Arabia, 26-27 January, 2015,2097-2108,2015.
- [4] World Bank, Iraq: Country Water Resources, Assistance Strategy: Addressing Major Threats to People's Livelihoods, Report no. 36297-IQ, 97p., 2006.
- [5] Al-Ansari, N., Management of Water Resources in Iraq: Perspectives and Prognoses, *Engineering*, 5, 8, 667-68, 2013.
- [6] Al-Ansari, N.A. and Knutsson, S., Toward Prudent management of Water Resources in Iraq, *J. Advanced Science and Engineering Research*, 1,53-67,2011.
- [7] ECB, Engineering Consulting Bureau, Sedimentation study at the intake of North Al-Jazeera Irrigation project, Final report, Mosul University, College of Engineering, Contract No. 20, 2010.
- [8] Swiss consultants (1979). Mosul Dam Project-planning report.State organization of dams, Republic of Iraq, Ministry of Irrigation, Vol. 1.
- [9] Saleh, D. K., Stream Gage Descriptions and Stream flow Statistics for Sites in the Tigris River and Euphrates River Basins, Iraq. U.S. Geological Survey.Data series 540, 2010.
- [10] Ezz-Aldeen, M., Al-Ansari, N. A., and Knutsson, S., Sediment delivery from right bank valleys to Mosul reservoir, Iraq. *Journal of Ecology and Environmental Sciences*.3 (1), 50-53, 2012.
- [11] Najib, Y. E., Characteristics of Tigris River at Mosul. MSc thesis, College of Engineering, University of Mosul,1980.
- [12] UNEP, The Mesopotamian Marshlands: Demise of an Ecosystem, Early Warning and Assessment Technical Report no. 3, UNEP/DEWA/TR.01-3, (Geneva: UNEP), 2001.
- [13] Iraqi Ministry of Water Resources, Schematic diagram of main control structures in Iraq, General directorate of water resources management, hydrological studies centre, Baghdad, 2005.
- [14] Iraqi Ministry of Water Resources, Water Resources, Mosul Dam, 2012. [Available at: <http://dams.mowr.gov.iq/node/11> accessed 11 May 2012]
- [15] Ezz-Aldeen, M., Al-Ansari, N.A., and Knutsson, S., Application of Swat Model to Estimate the Sediment Load from the Left Bank of Mosul Dam. *J. Advance Science and Engineering Research*, 3 (1), 47-61,2013
- [16] Sissakian, V.K. , Report on the geological mapping of TuzKhurmatu – Kifri – Kalar Area. Iraq Geological Survey Library report no. 902, 1978.
- [17] Sissakian, V.K. and Al-Mousawi, H.A., Karstification and related problems, examples from Iraq. *Iraqi Bulletin of Geology and Mining*, 3, 2, 1 – 12, 2007.
- [18] Al-Ansari, N.A., Al-Jabbari, M., Barazachi, A. and Gayarah, A., Geological, geophysical and hydrological investigation of Mosul Dam area, Report submitted to the Iraqi Ministry of Irrigation, 1984,.
- [19] Wheeler, M.,Ackers, J.,Bartlett,J.,Tarrant,F.,Dunlop,C. and Campbell,P., Mosul Dam Study, Task Order 8, Blach&Veatch, Surrey, UK.), 2005.
- [20] Wakeley, L. D., Kelley, J. R., Talbot, C. A., Pearson, M .L., and Broadfoot, S. W. Geologic Conceptual Model of Mosul Dam. U.S. Army Engineer Research and Development Center, 61 pp, 2007.

- [21] Sissakian, V.K., Abdul Ahad, A.D. and Hamid, A.T., Geological Hazards in Iraq, Classification and geographical distribution. Iraqi Bull. Geol. Min., 7, 1, 1 – 28,2011.
- [22] Fouad, S.F., Tectonic Map of Iraq, scale 1: 1000000, 3rd edition. Iraq Geological Survey Publications, Baghdad, Iraq, 2012.
- [23] Saleh, H.A., Structural analysis of Sasan –Ishkaft Fault. Unpublished M.Sc. Theses, Baghdad University, Baghdad, Iraq, 2004.
- [24] Kelly, J., Wakeley, L.D., Broadfoot, S.W., Pearson, M.L., McGill, T.E., Jorgeson, J.D., Talbot, C.A. and McGrath, C.J., Geologic Setting of Mosul Dam and Its Engineering Implications, Final Report, U.S. Army Engineer District, Gulf Region, Baghdad, Iraq,2007.
- [25] Sissakian, V.K. and Ibrahim, F.A., Geological Hazards Map of Mosul Quadrangle, Scale 1:250000. Iraq Geological Survey Library report no. 2860, 2004.
- [26] Black and Veatch, Mosul Dam Assessment. Review of 1984 Dambreak and Floodwave Study for Mosul Dam. Mosul Dam Library, Iraq, 2004.
- [27] Mark and Wheeler, Mosul Dam Assessment Task Order No. 8. Report on Site Visit, Mosul Dam Library, 3 – 7 September, 2004.
- [28] Washington Group International, Inter-Office Correspondence. Mosul Dam Library, 2005.
- [29] Hijab, S.R. and Al-Jabbar, M.A., Geophysical Investigation on Mosul Dam Area, Stage One. Emergency Microgravity Survey.Iraq Geological Survey Library.internal report, 2006.
- [30] Sissakian, V.K., Al-Ansari, N. and Knutson, S., Karstification problems in Mosul Dam and its assessment, North Iraq, Engineering, 6, 2, 84-92, 2014.
- [31] Lane, P.A and Griffiths, D.V., Assessment of stability of slopes under drawdown conditions, Journal of Geotechnical and Geoenvironmental Engineering, 126, 443–450, 2000.
- [32] Sissakian, V.K., Fouad, S.F. and Salih, H.A, The Landslides of Khanooqa Area, Central part of Iraq. Iraqi Journal of Earth Sciences, 3, 1, Mosul University, Mosul, Iraq, 2003.
- [33] Sissakian, V.K., Fouad, S.F. and Al-Musawi, H.A., The influence of the unstable slopes on the stability of Makhul Dam, Central Iraq. Iraqi Bull. Geol. Min., 2, 1, 31 – 44, 2005.
- [34] Xu, S. Dang, F., Han, Q. and Cheng, S., Engineering Computation, International Conference on Analysis of Stability of Dam Slope during Rapid Drawdown of Reservoir Water Level. Honk Kong. 2 – 3 May, 2009. ISBN: 978-0-7695-3655-2, p. 221 – 224, 2009.
- [35] Keming, S. and Bagale, M.R., Study on dam slope stability under the condition of rainfall, International Journal of Science and Technology Research, 1, 5, 2012. ISSN 2277-8616, 2012.
- [36] IVO, ImatranVoimaOsakeyhtio, Consulting Engineers, Finland, Geologic Map of Mosul Dam, Ministry of Agrarian Reform, Iraq, 1969.